

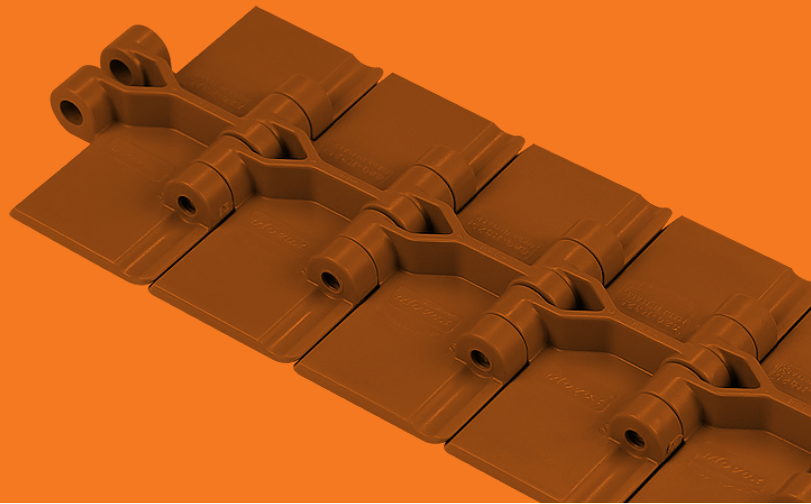









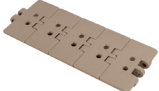





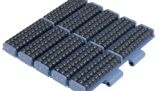

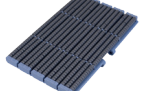











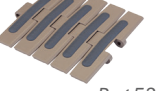
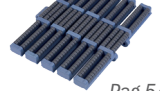

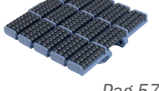

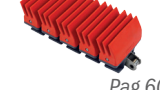
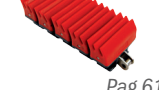

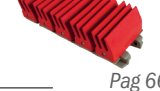
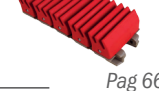

62

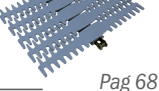
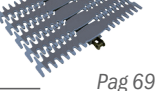

Plastic chains

820  Pag 31-32	820 V  Pag 33	820 Plastic pin  Pag 33	828  Pag 34	831  Pag 35	821  Pag 36
821 GT  Pag 37	821 LBP  Pag 38	8257  Pag 39	8257 GT  Pag 40	8257 LBP  Pag 41	878 TAB  Pag 42
879 M  Pag 43	879 TAB  Pag 44	888  Pag 45	888 GT  Pag 46	880 M  Pag 47	880 TAB  Pag 48
880 V TAB  Pag 49	880 TAB Plastic pin  Pag 49	880 B  Pag 50	880 TAB B0  Pag 51	882 M  Pag 52	882 M GT  Pag 53
882 M LBP  Pag 54	882 TAB  Pag 55	882 TAB GT  Pag 56	882 TAB LBP  Pag 57	1873  Pag 58	1873 GT  Pag 59
1873 GRIPPER GS1  Pag 60	1873 GRIPPER GS2  Pag 61	1873 GRIPPER GS4  Pag 62	1873 D-SHAPE  Pag 63	1873 MX1  Pag 64	1873 MX2  Pag 65
878 GRIPPER GS1  Pag 66	878 GRIPPER GS2  Pag 66	878 GRIPPER GS4  Pag 66	1843  Pag 67	SP 1883  Pag 68	SP 1883 GT  Pag 69
CC 600  Pag 70	CC 600 TAB  Pag 70	CC 600 D  Pag 71	CC 600 D TAB  Pag 71	CC 1400  Pag 72	CC 1400 TAB  Pag 72

1701 TAB OP

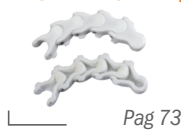

Pag 73

1701 TAB OPF

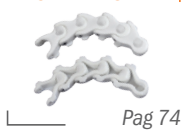

Pag 74

1706

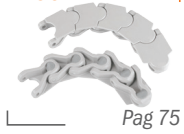

Pag 75

1706 TAB



Pag 75

765 NO GAP

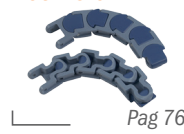

Pag 76

43 MF



Pag 77

63 MF



Pag 77

83 MF



Pag 77

103 MF



Pag 77

83 M



Pag 78

140 M



Pag 78

83 M/PU



Pag 79

820

Catena rettilinea
Straight running chain / Geradegängige Scharnierbandkette

Pins: Stainless Steel | Backflex radius min.: 50 mm

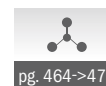
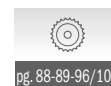
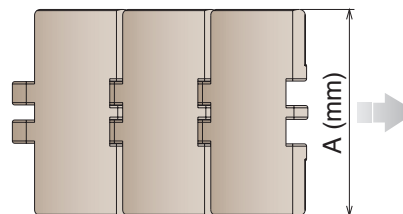
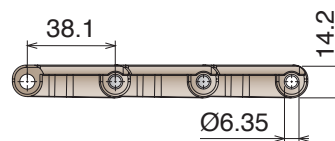
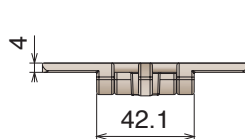

Article-Nr.	Ref.	A (Plate Width) mm	Weight kg/m	Max working load (N)	Material
11010102	LF 820 K325	82,5	0,89	1625	LF
11010103	LF 820 K330	83,8	0,90		
11010104	LF 820 K350	88,9	0,91		
11010114	LF 820 K400	101,6	0,95		
11010105	LF 820 K450	114,3	1,00		
11010106	LF 820 K600	152,4	1,22		
11010107	LF 820 K750	190,5	1,43		
11010302	MX 820 K325	82,5	0,89	1260	MX
11010303	MX 820 K330	83,8	0,90		
11010304	MX 820 K350	88,9	0,91		
11010314	MX 820 K400	101,6	0,95		
11010305	MX 820 K450	114,3	1,00		
11010306	MX 820 K600	152,4	1,22		
11010307	MX 820 K750	190,5	1,43		
11012502	MPX 820 K325	82,5	0,89	1625	MPX
11012503	MPX 820 K330	83,8	0,90		
11012504	MPX 820 K350	88,9	0,91		
11012514	MPX 820 K400	101,6	0,95		
11012505	MPX 820 K450	114,3	1,00		
11012506	MPX 820 K600	152,4	1,22		
11012507	MPX 820 K750	190,5	1,43		

820

Catena rettilinea
Straight running chain / Geradegängige Scharnierbandkette

Pins: Stainless Steel | Backflex radius min.: 50 mm

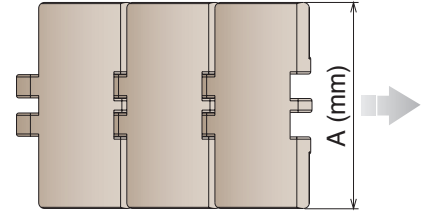
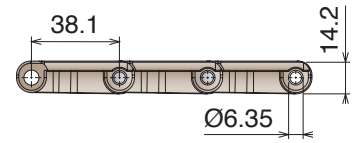
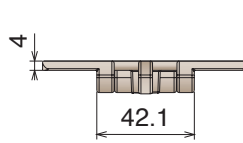

80 links



pg. 88-89-96/104

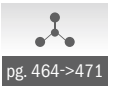

pg. 464->471

Article-Nr.	Ref.	A (Plate Width) mm	Weight kg/m	Max working load (N)	Material
11011602	DKM 820 K325	82,5	0,89	1625	DKM
11011603	DKM 820 K330	83,8	0,90		
11011604	DKM 820 K350	88,9	0,91		
11011614	DKM 820 K400	101,6	0,95		
11011605	DKM 820 K450	114,3	1,00		
11011606	DKM 820 K600	152,4	1,22		
11011607	DKM 820 K750	190,5	1,43		
11011702	MWX 820 K325	82,5	0,89	1625	MWX
11011703	MWX 820 K330	83,8	0,90		
11011704	MWX 820 K350	88,9	0,91		
11011714	MWX 820 K400	101,6	0,95		
11011705	MWX 820 K450	114,3	1,00		
11011706	MWX 820 K600	152,4	1,22		
11011707	MWX 820 K750	190,5	1,43		

820 V

Catena rettilinea
Straight running chain / Geradegängige Scharnierbandkette

Pins: Stainless Steel | Backflex radius min.: 50 mm

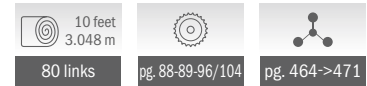
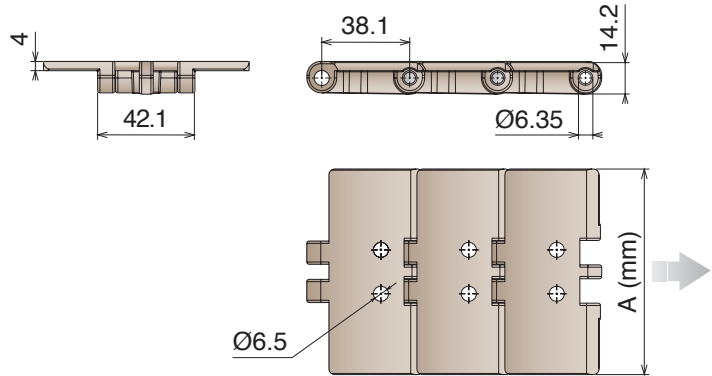
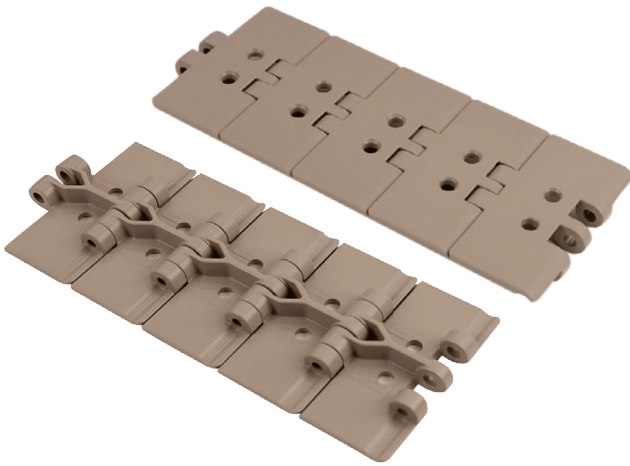

Article-Nr.	Ref.	A (Plate Width) mm	Weight kg/m	Max working load (N)	Material
11550102	LF 820 V2 K325	82,5	0,89	1625	LF
11550105	LF 820 V2 K450	114,3	1,00		
11550302	MX 820 V2 K325	82,5	0,89	1260	MX
11550305	MX 820 V2 K450	114,3	1,00		

820 Plastic pin

Catena rettilinea con perno in plastica
Straight running chain with plastic pin / Geradegängige Scharnierbandkette mit plastic bolzen

Pins: Plastic | Backflex radius min.: 50 mm

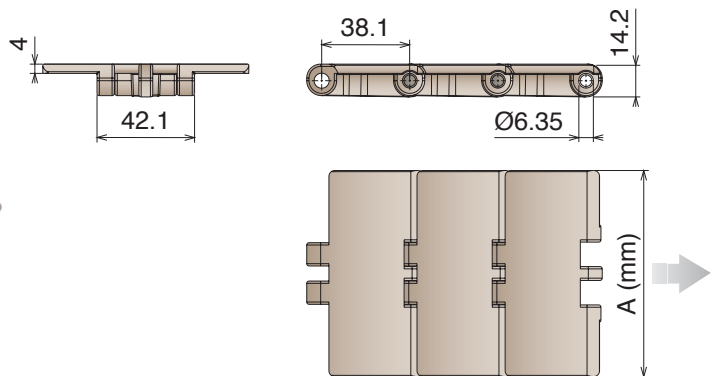

Article-Nr.	Ref.	A (Plate Width) mm	Weight kg/m	Max working load (N)	Material
11630102	LF 820 K325	82,5	0,69	650	LF
11630105	LF 820 K450	114,3	0,80		

828

Catena rettilinea
Straight running chain / Geradegängige Scharnierbandkette

Pins: Stainless Steel | Backflex radius min.: 50 mm

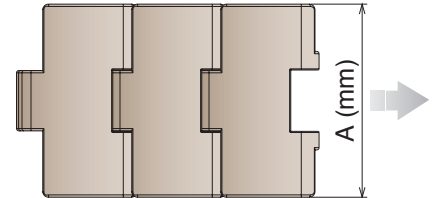
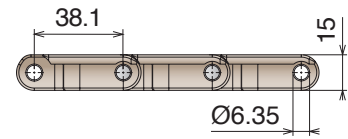
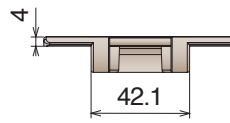
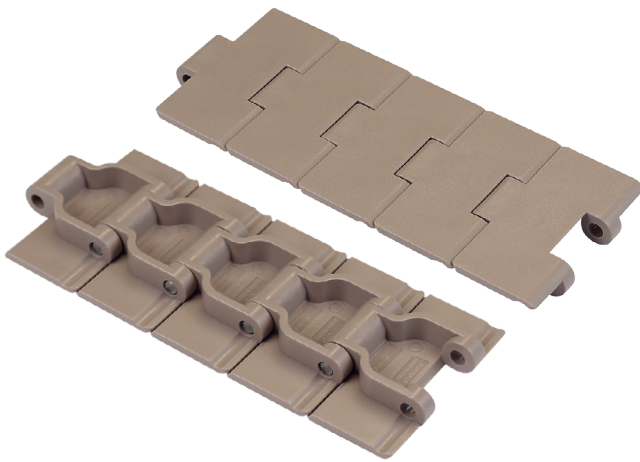

80 links



pg. 90-91/104

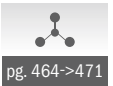

pg. 464->471

Article-Nr.	Ref.	A (Plate Width) mm	Weight kg/m	Max working load (N)	Material
11020102	LF 828 K325	82,5	1,07	2320	LF
11020103	LF 828 K330	83,8	1,13		
11020302	MX 828 K325	82,5	1,07	1860	MX
11020303	MX 828 K330	83,8	1,13		
11022502	MPX 828 K325	82,5	1,07	2320	MPX
11022503	MPX 828 K330	83,8	1,13		
11021602	DKM 828 K325	82,5	1,07	2320	DKM
11021603	DKM 828 K330	83,8	1,13		
11021702	MWX 828 K325	82,5	1,07	2320	MWX
11021703	MWX 828 K330	83,8	1,13		

831

Catena rettilinea
Straight running chain / Geradegängige Scharnierbandkette

Pins: Stainless Steel | Backflex radius min.: 50 mm

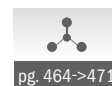
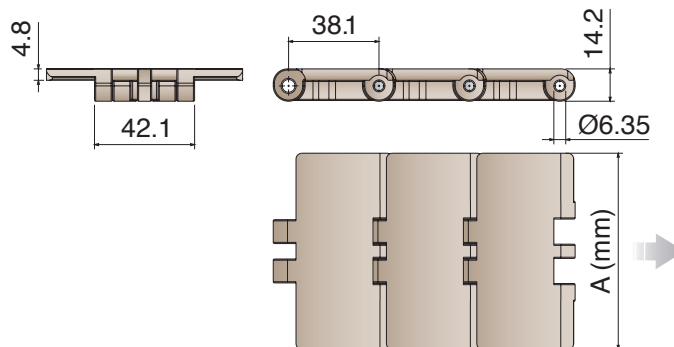

Article-Nr.	Ref.	A (Plate Width) mm	Weight kg/m	Max working load (N)	Material
11030102	LF 831 K325	82,5	1,00	1625	LF
11030105	LF 831 K450	114,3	1,28		
11030107	LF 831 K750	190,5	1,80		
11030302	MX 831 K325	82,5	1,00	1260	MX
11030305	MX 831 K450	114,3	1,28		
11030307	MX 831 K750	190,5	1,80		
11032502	MPX 831 K325	82,5	1,00	1625	MPX
11032505	MPX 831 K450	114,3	1,28		
11032507	MPX 831 K750	190,5	1,80		
11031602	DKM 831 K325	82,5	1,00	1625	DKM
11031605	DKM 831 K450	114,3	1,28		
11031607	DKM 831 K750	190,5	1,80		
11031702	MWX 831 K325	82,5	1,00	1625	MWX
11031705	MWX 831 K450	114,3	1,28		
11031707	MWX 831 K750	190,5	1,80		

821

Catena rettilinea
Straight running chain / Geradegängige Scharnierbandkette

Pins: Stainless Steel | Backflex radius min.: 50 mm

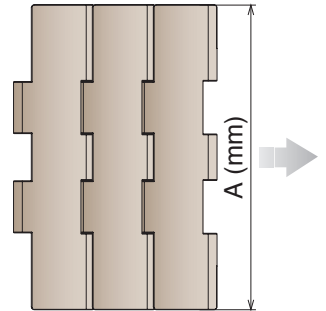
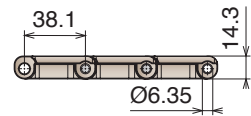
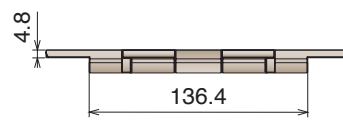

80 links



pg. 86/105

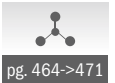

pg. 464->471

Article-Nr.	Ref.	A (Plate Width) mm	Weight kg/m	Max working load (N)	Material
11040107	LF 821 K750	190,5	2,55	2770	LF
11040108	LF 821 K1000	254,0	3,05		
11040109	LF 821 K1200	304,8	3,35		
11040307	MX 821 K750	190,5	2,55	2200	MX
11040308	MX 821 K1000	254,0	3,05		
11040309	MX 821 K1200	304,8	3,35		
11042507	MPX 821 K750	190,5	2,55	2770	MPX
11042508	MPX 821 K1000	254,0	3,05		
11042509	MPX 821 K1200	304,8	3,35		
11041607	DKM 821 K750	190,5	2,55	2770	DKM
11041608	DKM 821 K1000	254,0	3,05		
11041609	DKM 821 K1200	304,8	3,35		
11041707	MWX 821 K750	190,5	2,55	2770	MWX
11041708	MWX 821 K1000	254,0	3,05		
11041709	MWX 821 K1200	304,8	3,35		

821 GT **Catena rettilinea** Straight running chain / Geradegängige Scharnierbandkette

Pins: Stainless Steel | Backflex radius min.: 50 mm | TPE Rubber: 75 ShA

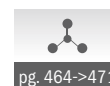
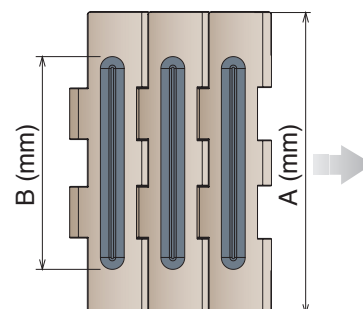
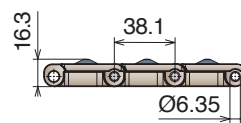
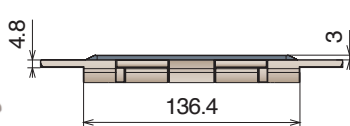

Article-Nr.	Ref.	A (Plate Width) mm	B (Rubber Width) mm	Weight kg/m	Max working load (N)	Material
11050107	LF 821 GT K750	190,5	134,0	2,55	2770	LF
11050108	LF 821 GT K1000	254,0	192,0	3,05		
11050109	LF 821 GT K1200	304,8	252,0	3,35		
11050307	MX 821 GT K750	190,5	134,0	2,55	2200	MX
11050308	MX 821 GT K1000	254,0	192,0	3,05		
11050309	MX 821 GT K1200	304,8	252,0	3,35		

821 LBP

Catene in plastica / Plastic chains / Scharnierbandketten aus Kunststoff

821 LBP

Catena rettilinea
Straight running chain / Geradegängige Scharnierbandkette

Pins: Stainless Steel | Backflex radius min.: 150 mm

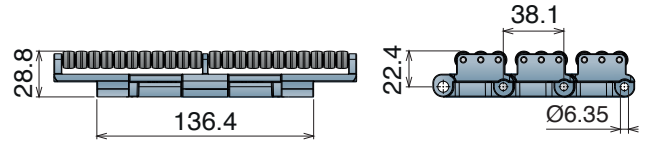
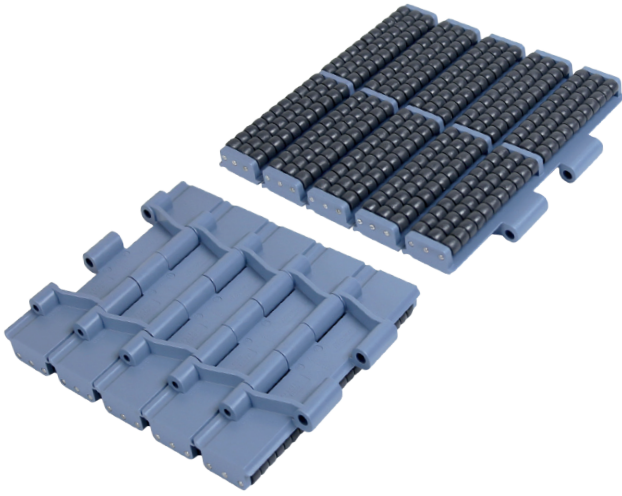

K750

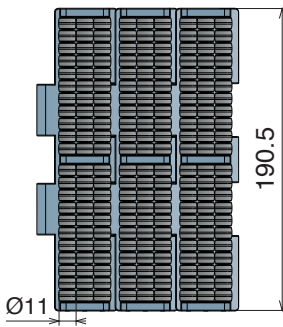

K1000

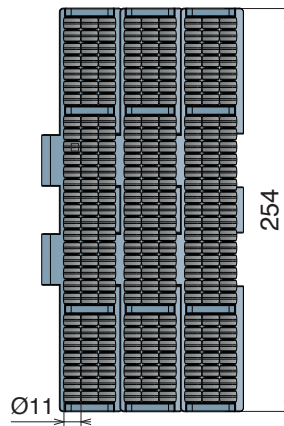

K1200

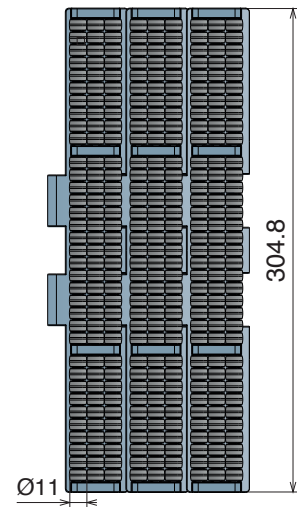

5 feet
1.524 m
40 links

pg. 86/105

pg. 464->471

Article-Nr.	Ref.	A (Plate Width) mm	Weight kg/m	Max working load (N)	Material
11060107	LFA 821 LBP K750	190,5	5,70	2770	LFA
11060108	LFA 821 LBP K1000	254,0	7,05		
11060109	LFA 821 LBP K1200	304,8	8,21		

8257

Catena rettilinea
Straight running chain / Geradegängige Scharnierbandkette

Pins: Stainless Steel | Backflex radius min.: 50 mm

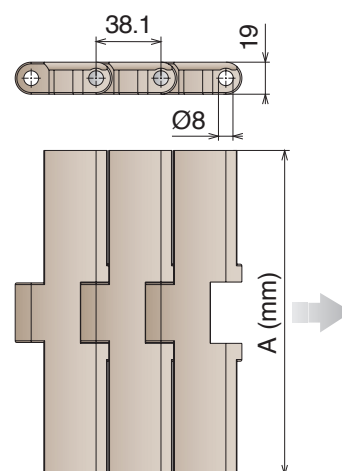
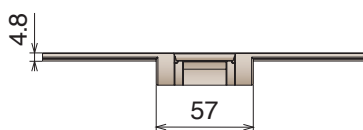
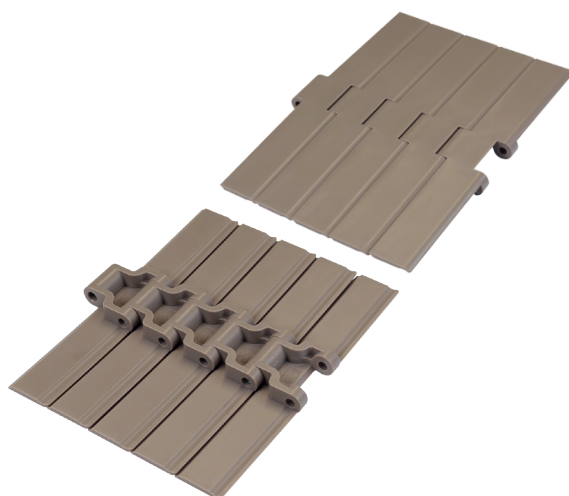

10 feet
3.048 m



pg. 92-93/105



pg. 464->471

80 links

Article-Nr.	Ref.	A (Plate Width) mm	Weight kg/m	Max working load (N)	Material
11070107	LF 8257 K750	190,5	2,55	3830	LF
11070108	LF 8257 K1000	254,0	3,05		
11070109	LF 8257 K1200	304,8	3,35		
11070307	MX 8257 K750	190,5	2,55	3050	MX
11070308	MX 8257 K1000	254,0	3,05		
11070309	MX 8257 K1200	304,8	3,35		
11072507	MPX 8257 K750	190,5	2,55	3830	MPX
11072508	MPX 8257 K1000	254,0	3,05		
11072509	MPX 8257 K1200	304,8	3,35		
11071607	DKM 8257 K750	190,5	2,55	3830	DKM
11071608	DKM 8257 K1000	254,0	3,05		
11071609	DKM 8257 K1200	304,8	3,35		
11071707	MWX 8257 K750	190,5	2,55	3830	MWX
11071708	MWX 8257 K1000	254,0	3,05		
11071709	MWX 8257 K1200	304,8	3,35		

8257 GT

Catene in plastica / Plastic chains / Scharnierbandketten aus Kunststoff

8257 GT

Catena rettilinea
Straight running chain / Geradegängige Scharnierbandkette

Pins: Stainless Steel | Backflex radius min.: 50 mm | TPE Rubber: 75 ShA

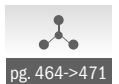
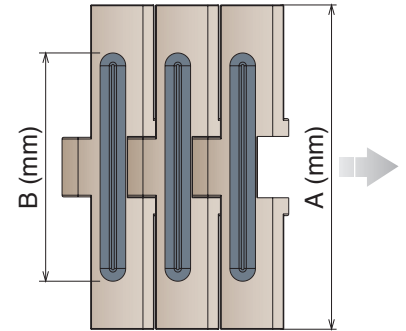
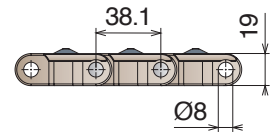
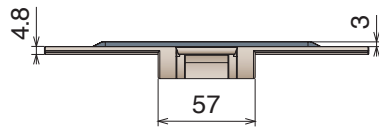
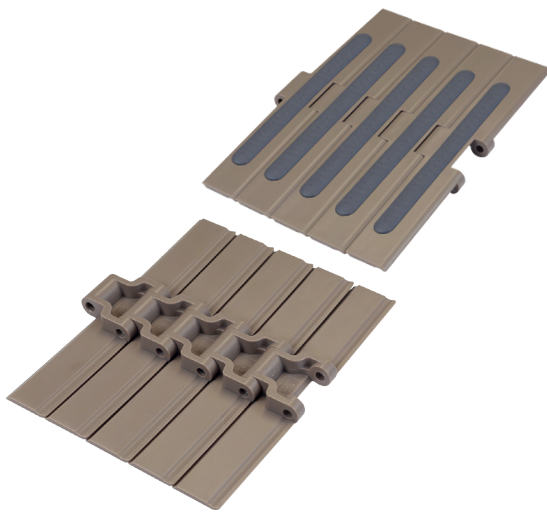

Article-Nr.	Ref.	A (Plate Width) mm	B (Rubber Width) mm	Weight kg/m	Max working load (N)	Material
11080107	LF 8257 GT K750	190,5	134,0	2,55	3830	LF
11080108	LF 8257 GT K1000	254,0	192,0	2,60		
11080109	LF 8257 GT K1200	304,8	252,0	2,95		
11080307	MX 8257 GT K750	190,5	134,0	2,55	3050	MX
11080308	MX 8257 GT K1000	254,0	192,0	2,60		
11080309	MX 8257 GT K1200	304,8	252,0	2,95		

8257 LBP

Catena rettilinea
Straight running chain / Geradegängige Scharnierbandkette

Pins: Stainless Steel | Backflex radius min.: 200 mm

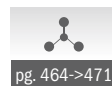
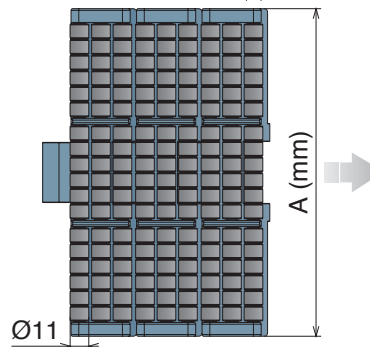
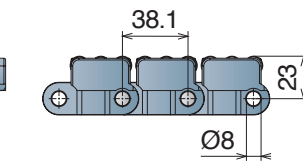
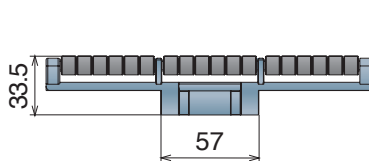
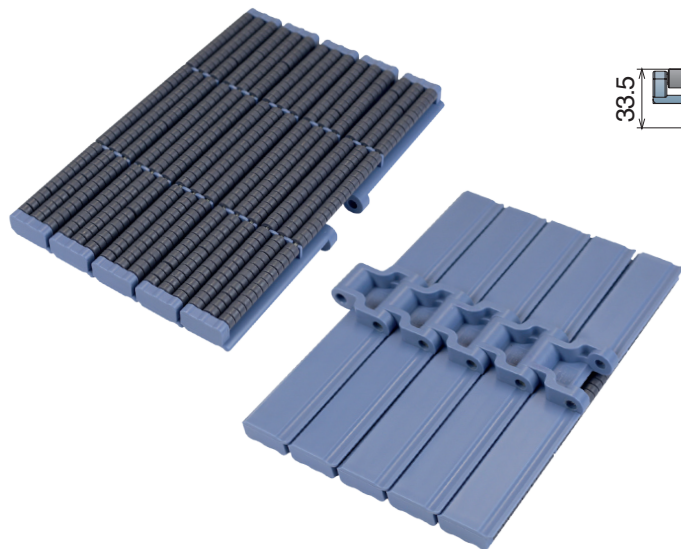

Article-Nr.	Ref.	A (Plate Width) mm	Weight kg/m	Max working load (N)	Material
11090107	LFA 8257 LBP K750	190,5	5,65	3830	LFA
11090108	LFA 8257 LBP K1000	254,0	7,16		
11090109	LFA 8257 LBP K1200	304,8	8,05		

878 TAB

Catene in plastica / Plastic chains / Scharnierbandketten aus Kunststoff

878 TAB

Catena curvilinea
Sideflexing chain / Kurvengängige Scharnierbandkette

Pins: Stainless Steel | Backflex radius min.: 40 mm

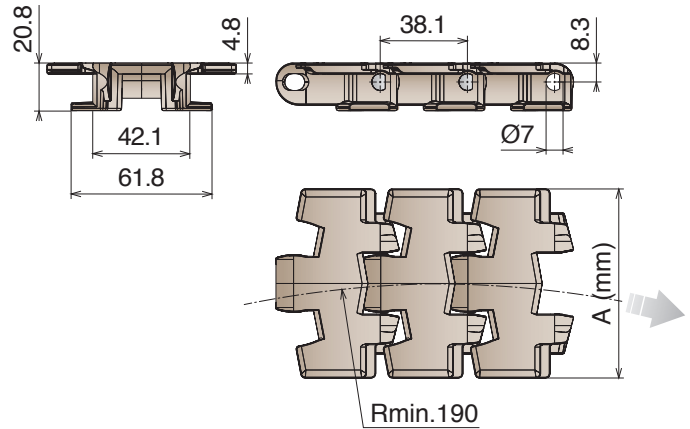
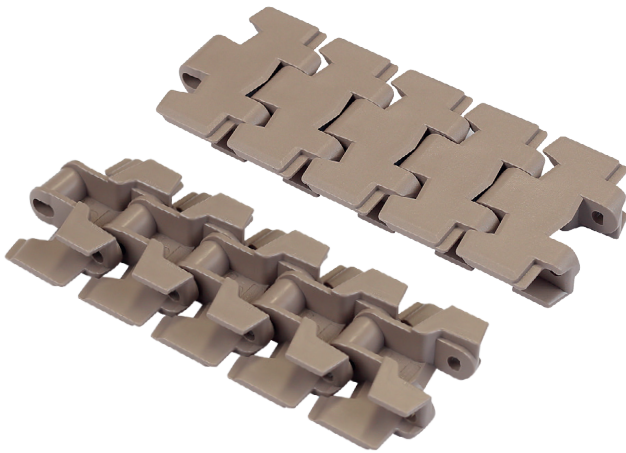

Tab System

10 feet
3,048 m
80 links

pg. 90-91

pg. 157/162

pg. 464->471

Article-Nr.	Ref.	A (Plate Width) mm	Weight kg/m	Max working load (N)	Material
11190102	LF 878 TAB K325	82,5	1,06	2200	LF
11190105	LF 878 TAB K450	114,3	1,18		
11190302	MX 878 TAB K325	82,5	1,06	1750	MX
11190305	MX 878 TAB K450	114,3	1,18		
11192502	MPX 878 TAB K325	82,5	1,06	2200	MPX
11191602	DKM 878 TAB K325	82,5	1,06	2200	DKM
11191702	MWX 878 TAB K325	82,5	1,06	2200	MWX

879 M

Catena curvilinea
Sideflexing chain / Kurvengängige Scharnierbandkette

Pins: Ferritic Stainless Steel | Backflex radius min.: 50 mm

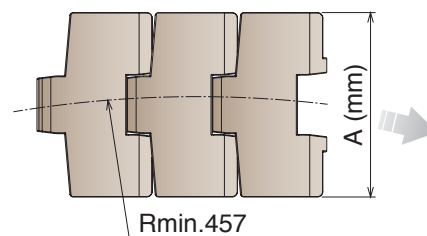
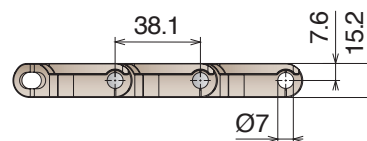
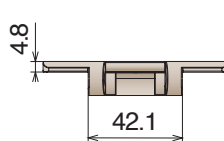
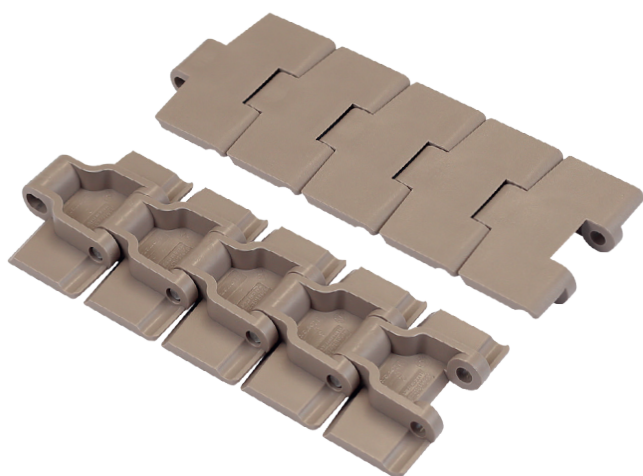

Magnetic System

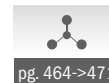

Article-Nr.	Ref.	A (Plate Width) mm	R mm	Weight kg/m	Max working load (N)	Material
11240102	LF 879 M K325	82,5	457	1,05	2200	LF
11240105	LF 879 M K450	114,3	457	1,15		
11240302	MX 879 M K325	82,5	457	1,05	1750	MX
11240305	MX 879 M K450	114,3	457	1,15		
11242502	MPX 879 M K325	82,5	457	1,05	2200	MPX
11242505	MPX 879 M K450	114,3	457	1,15		
11241602	DKM 879 M K325	82,5	457	1,05	2200	DKM
11241605	DKM 879 M K450	114,3	457	1,15		
11241702	MWX 879 M K325	82,5	457	1,05	2200	MWX
11241705	MWX 879 M K450	114,3	457	1,15		

879 TAB

Catene in plastica / Plastic chains / Scharnierbandketten aus Kunststoff

879 TAB

Catena curvilinea
Sideflexing chain / Kurvengängige Scharnierbandkette

Pins: Stainless Steel | Backflex radius min.: 50 mm

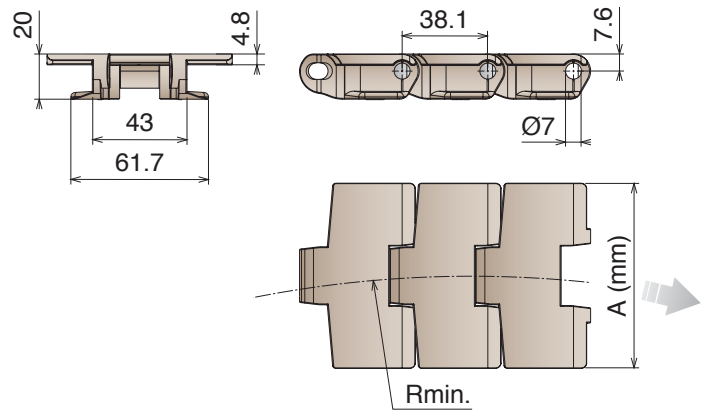
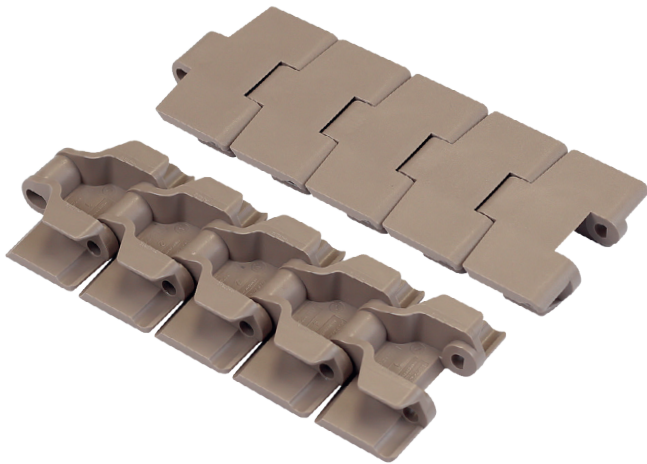

Tab System

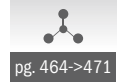

Article-Nr.	Ref.	A (Plate Width) mm	R mm	Weight kg/m	Max working load (N)	Material
11250102	LF 879 TAB K325	82,5	457	1,01	2200	LF
11250105	LF 879 TAB K450	114,3	610	1,13		
11250302	MX 879 TAB K325	82,5	457	1,01	1750	MX
11250305	MX 879 TAB K450	114,3	610	1,13		
11252502	MPX 879 TAB K325	82,5	457	1,01	2200	MPX
11252505	MPX 879 TAB K450	114,3	610	1,13		
11251602	DKM 879 TAB K325	82,5	457	1,01	2200	DKM
11251605	DKM 879 TAB K450	114,3	610	1,13		
11251702	MWX 879 TAB K325	82,5	457	1,01	2200	MWX
11251705	MWX 879 TAB K450	114,3	610	1,13		

888

Catena curvilinea
Sideflexing chain / Kurvengängige Scharnierbandkette

Pins: Stainless Steel | Backflex radius min.: 40 mm

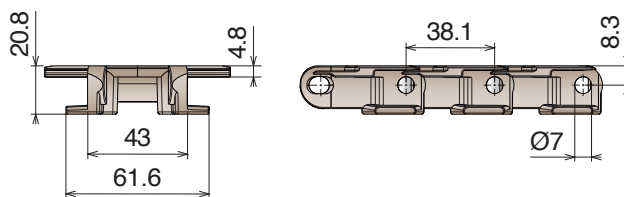
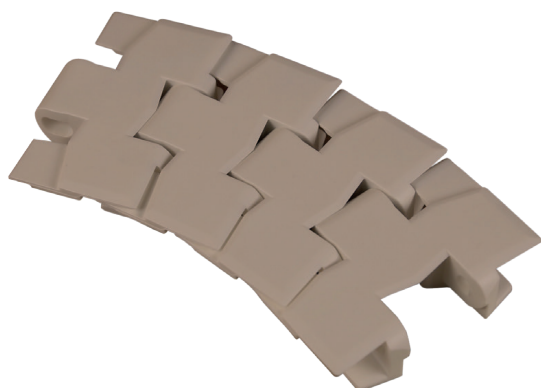

W80

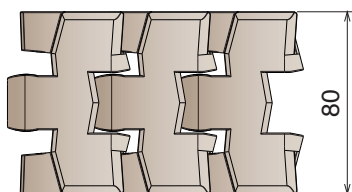

W140

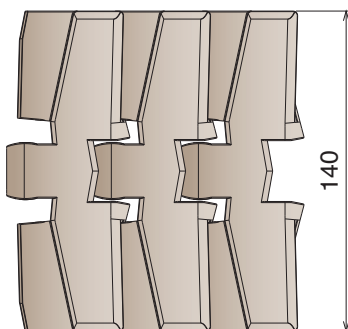

W200

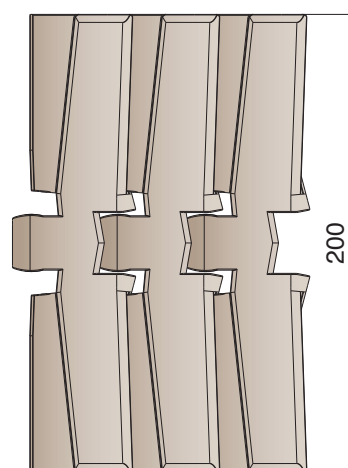

Tab System

- 10 feet
3.048 m
80 links
- pg. 90-91
- pg. 157/162
- pg. 464->471

Article-Nr.	Ref.	A (Plate Width) mm	R mm	Weight kg/m	Max working load (N)	Material
11700119	LF 888 W80	80,0	200	1,05	2200	LF
11700120	LF 888 W140	140,0	500	1,32		
11700121	LF 888 W200	200,0	500	1,62		

888 GT

Catene in plastica / Plastic chains / Scharnierbandketten aus Kunststoff

888 GT

Catena curvilinea
Sideflexing chain / Kurvengängige Scharnierbandkette

Pins: Stainless Steel | Backflex radius min.: 40 mm | TPE Rubber: 75 ShA

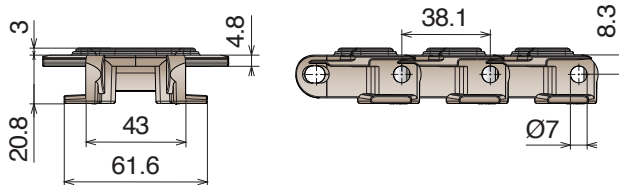
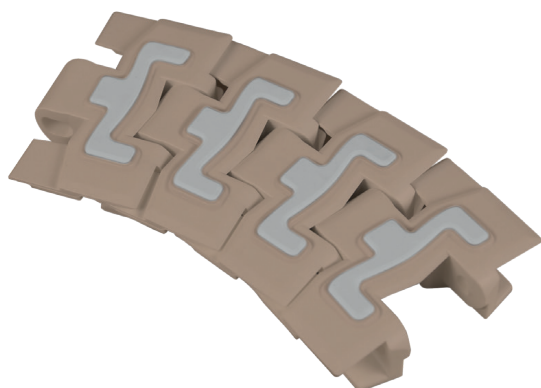

W80

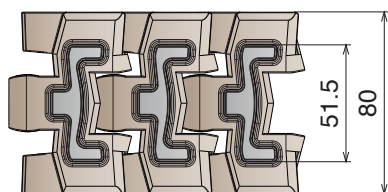

W140

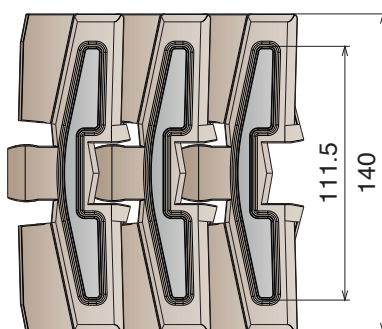

W200

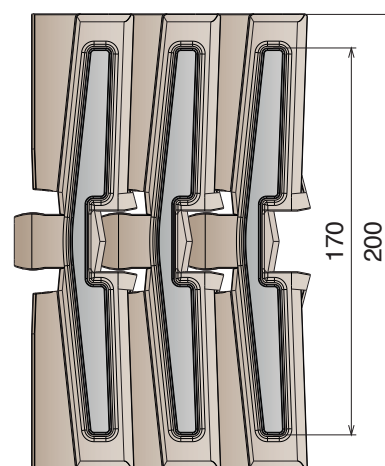

Tab System

10 feet 3,048 m			
80 links	pg. 90-91	pg. 157/162	pg. 464->471

Article-Nr.	Ref.	A (Plate Width) mm	R mm	Weight kg/m	Max working load (N)	Material
11710119	LF 888 GT W80	80,0	200	1,15	2200	LF
11710120	LF 888 GT W140	140,0	500	1,43		
11710121	LF 888 GT W200	200,0	500	1,75		

880 M Catena curvilinea Sideflexing chain / Kurvengängige Scharnierbandkette

Pins: Ferritic Stainless Steel | Backflex radius min.: 50 mm

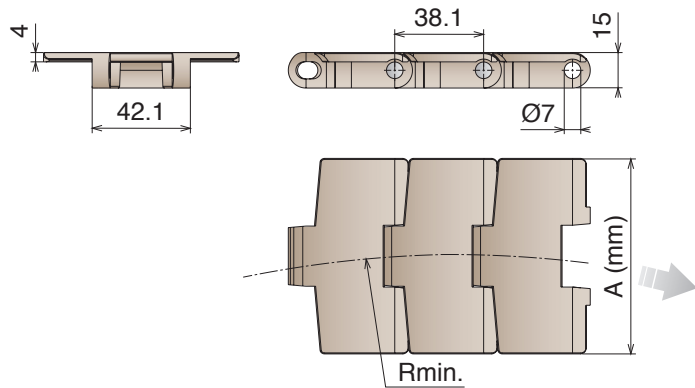
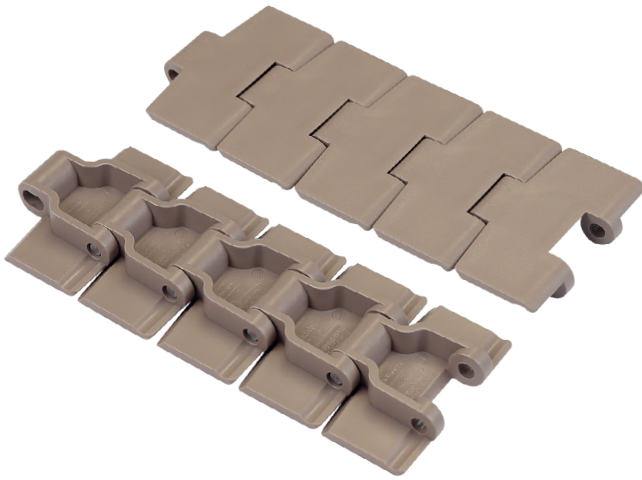

Magnetic System

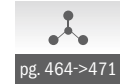

Article-Nr.	Ref.	A (Plate Width) mm	R mm	Weight kg/m	Max working load (N)	Material
11100102	LF 880 M K325	82,5	500	1,05	2200	LF
11100103	LF 880 M K330	83,8	457	1,09		
11100105	LF 880 M K450	114,3	457	1,15		
11100302	MX 880 M K325	82,5	500	1,05	1750	MX
11100303	MX 880 M K330	83,8	457	1,09		
11100305	MX 880 M K450	114,3	457	1,15		
11102502	MPX 880 M K325	82,5	500	1,05	2200	MPX
11102503	MPX 880 M K330	83,8	457	1,09		
11102505	MPX 880 M K450	114,3	457	1,15		
11101602	DKM 880 M K325	82,5	500	1,05	2200	DKM
11101603	DKM 880 M K330	83,8	457	1,09		
11101605	DKM 880 M K450	114,3	457	1,15		
11101702	MWX 880 M K325	82,5	500	1,05	2200	MWX
11101703	MWX 880 M K330	83,8	457	1,09		
11101705	MWX 880 M K450	114,3	457	1,15		

880 TAB

Catene in plastica / Plastic chains / Scharnierbandketten aus Kunststoff

880 TAB

Catena curvilinea
Sideflexing chain / Kurvengängige Scharnierbandkette

Pins: Stainless Steel | Backflex radius min.: 40 mm

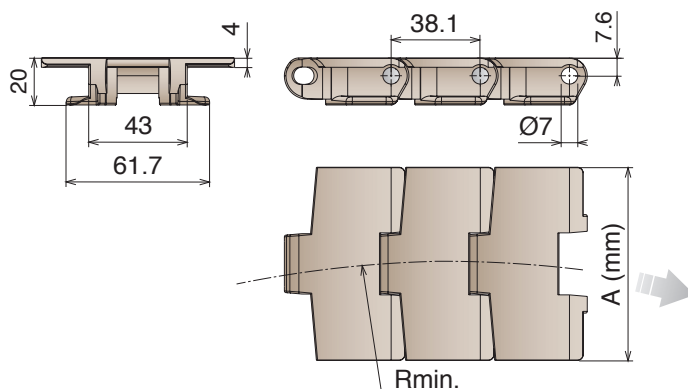
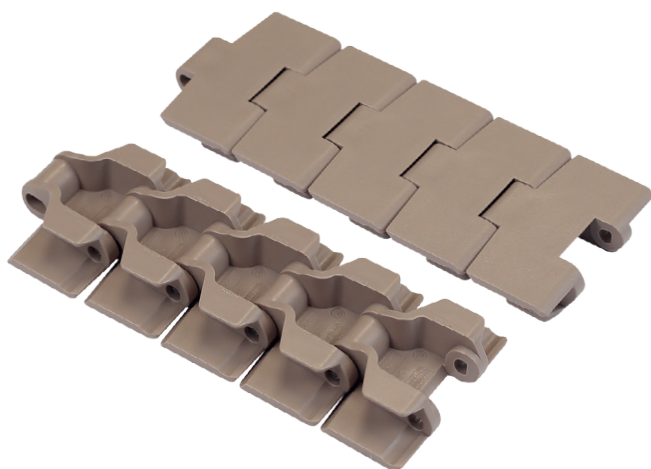

Tab System

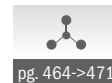

Article-Nr.	Ref.	A (Plate Width) mm	R mm	Weight kg/m	Max working load (N)	Material
11110102	LF 880 TAB K325	82,5	500	1,015	2200	LF
11110103	LF 880 TAB K330	83,8	457	1,018		
11110105	LF 880 TAB K450	114,3	457	1,09		
11110302	MX 880 TAB K325	82,5	500	1,015	1750	MX
11110303	MX 880 TAB K330	83,8	457	1,018		
11110305	MX 880 TAB K450	114,3	457	1,09		
11112502	MPX 880 TAB K325	82,5	500	1,015	2200	MPX
11112503	MPX 880 TAB K330	83,8	457	1,018		
11112505	MPX 880 TAB K450	114,3	457	1,09		
11111602	DKM 880 TAB K325	82,5	500	1,015	2200	DKM
11111603	DKM 880 TAB K330	83,8	457	1,018		
11111605	DKM 880 TAB K450	114,3	457	1,09		
11111702	MWX 880 TAB K325	82,5	500	1,015	2200	MWX
11111703	MWX 880 TAB K330	83,8	457	1,018		
11111705	MWX 880 TAB K450	114,3	457	1,09		

880 V TAB

Catena curvilinea
Sideflexing chain / Kurvengängige Scharnierbandkette

Pins: Stainless Steel | Backflex radius min.: 40 mm

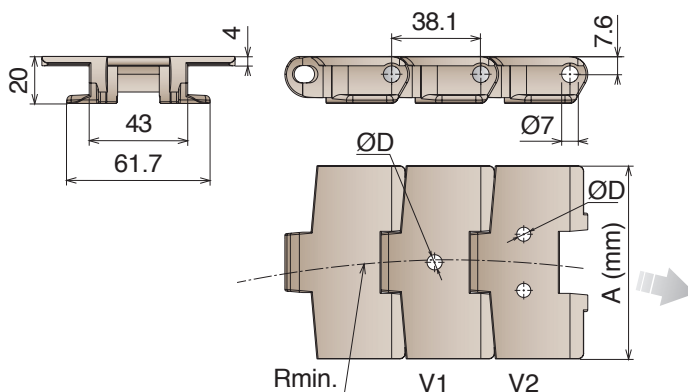
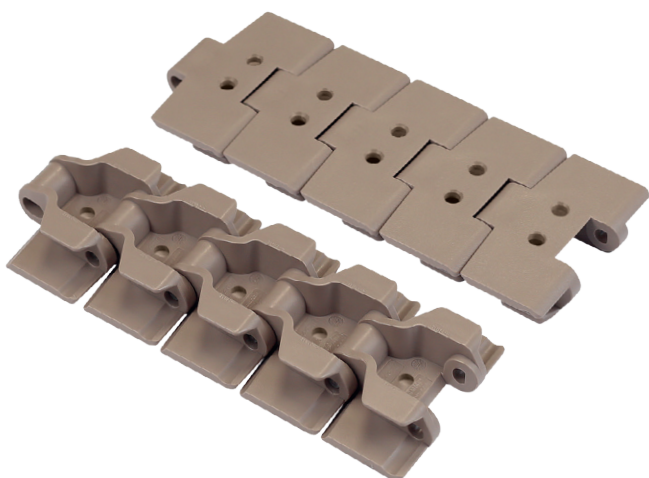

Tab System

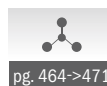
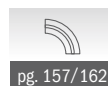

Article-Nr.	Ref.	A (Plate Width) mm	R mm	Weight kg/m	D mm	Max working load (N)	Material
11560102	LF 880 V1 K325	82,5	500	1,015	6,5	2200	LF
11570102	LF 880 V2 K325	82,5	500	1,015			
11570105	LF 880 V2 K450	114,3	457	1,09			

880 TAB Plastic pin

Catena curvilinea con perno in plastica
Sideflexing chain with plastic pin / Kurvengängige Scharnierbandkette mit plastic bolzen

Pins: Plastic | Backflex radius min.: 40 mm

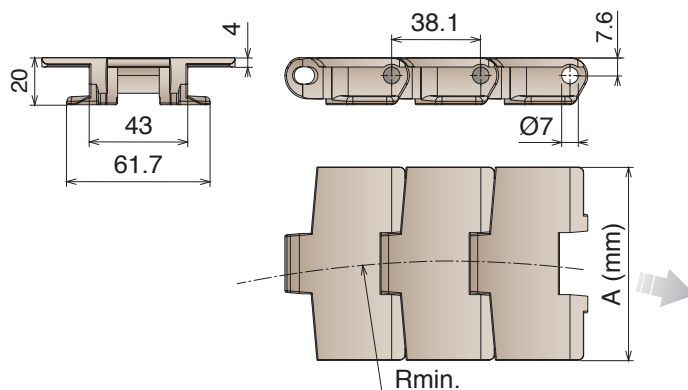
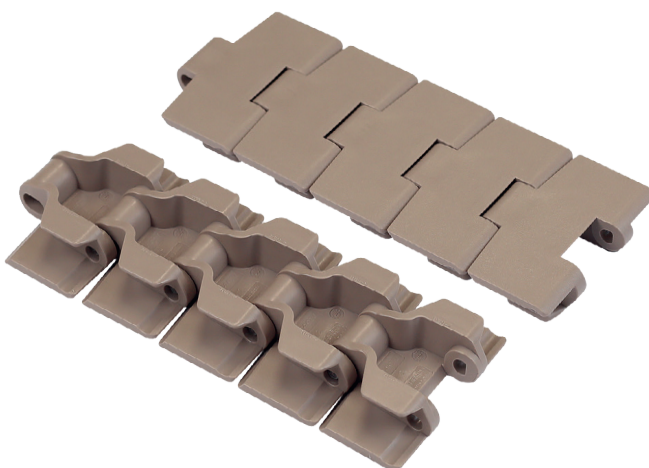

Tab System

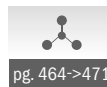

Article-Nr.	Ref.	A (Plate Width) mm	R mm	Weight kg/m	Max working load (N)	Material
11660102	LF 880 TAB K325	82,5	500	0,815	550	LF
11660105	LF 880 TAB K450	114,3	457	0,89		

880 B

Catene in plastica / Plastic chains / Scharnierbandketten aus Kunststoff

880 B

Catena curvilinea
Sideflexing chain / Kurvengängige Scharnierbandkette

Pins: Stainless Steel | Backflex radius min.: 40 mm

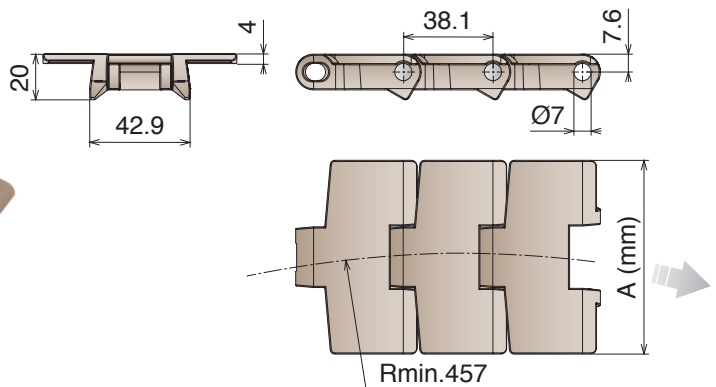

Bevel System

10 feet
3.048 m
80 links

pg. 90-91

pg. 161

pg. 464->471

Article-Nr.	Ref.	A (Plate Width) mm	R mm	Weight kg/m	Max working load (N)	Material
11120102	LF 880 B K325	82,5	457	0,89	2200	LF
11120104	LF 880 B K350	88,9	457	0,93		
11120105	LF 880 B K450	114,3	457	1,05		
11120302	MX 880 B K325	82,5	457	0,89	1750	MX
11120304	MX 880 B K350	88,9	457	0,93		
11120305	MX 880 B K450	114,3	457	1,05		

880 TAB BO

Catena curvilinea
Sideflexing chain / Kurvengängige Scharnierbandkette

Pins: Stainless Steel | Backflex radius min.: 40 mm

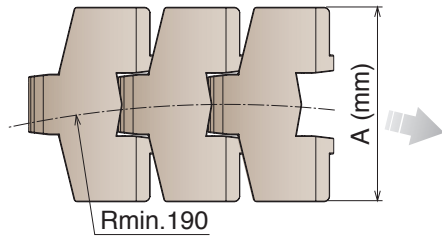
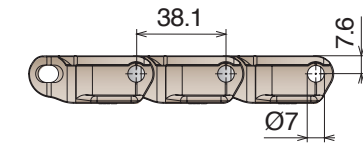
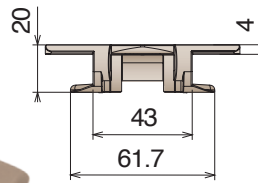

Tab System

10 feet
3.048 m
80 links

pg. 90-91

pg. 157/162

pg. 464->471

Article-Nr.	Ref.	A (Plate Width) mm	R mm	Weight kg/m	Max working load (N)	Material
11260102	LF 880 TAB BO K325	82,5	190	0,96	1680	LF
11260105	LF 880 TAB BO K450	114,3	190	1,10		
11260302	MX 880 TAB BO K325	82,5	190	0,96	1350	MX
11260305	MX 880 TAB BO K450	114,3	190	1,10		

882 M

Catena curvilinea
Sideflexing chain / Kurvengängige Scharnierbandkette

Pins: Ferritic Stainless Steel | Backflex radius min.: 50 mm

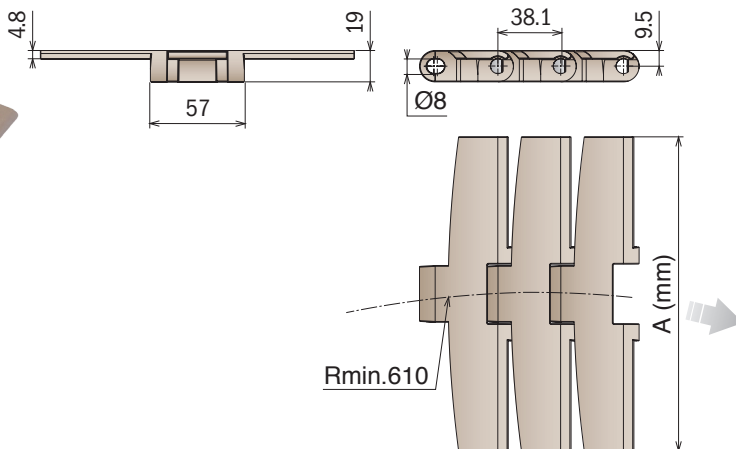
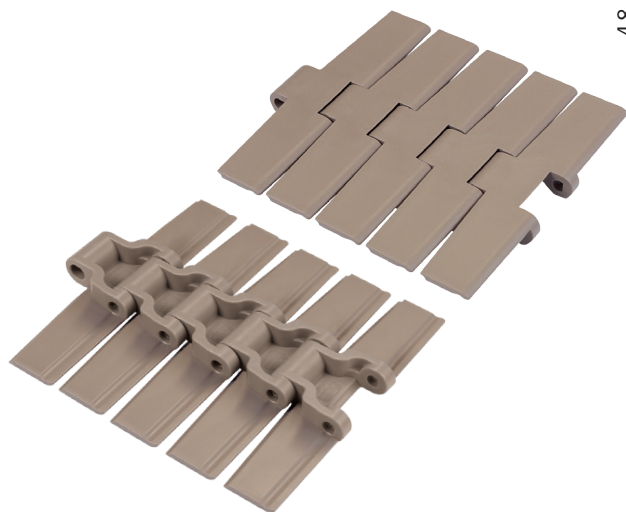

Magnetic System

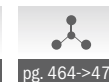

Article-Nr.	Ref.	A (Plate Width) mm	Weight kg/m	Max working load (N)	Material
11130107	LF 882 M K750	190,5	2,14	3830	LF
11130108	LF 882 M K1000	254,0	2,45		
11130109	LF 882 M K1200	304,8	2,68		
11130307	MX 882 M K750	190,5	2,14	3050	MX
11130308	MX 882 M K1000	254,0	2,45		
11130309	MX 882 M K1200	304,8	2,68		
11132507	MPX 882 M K750	190,5	2,14	3830	MPX
11132508	MPX 882 M K1000	254,0	2,45		
11132509	MPX 882 M K1200	304,8	2,68		
11131607	DKM 882 M K750	190,5	2,14	3830	DKM
11131608	DKM 882 M K1000	254,0	2,45		
11131609	DKM 882 M K1200	304,8	2,68		
11131707	MWX 882 M K750	190,5	2,14	3830	MWX
11131708	MWX 882 M K1000	254,0	2,45		
11131709	MWX 882 M K1200	304,8	2,68		

882 M GT

Catena curvilinea
Sideflexing chain / Kurvengängige Scharnierbandkette

Pins: Ferritic Stainless Steel | Backflex radius min.: 50 mm | TPE Rubber: 75 ShA

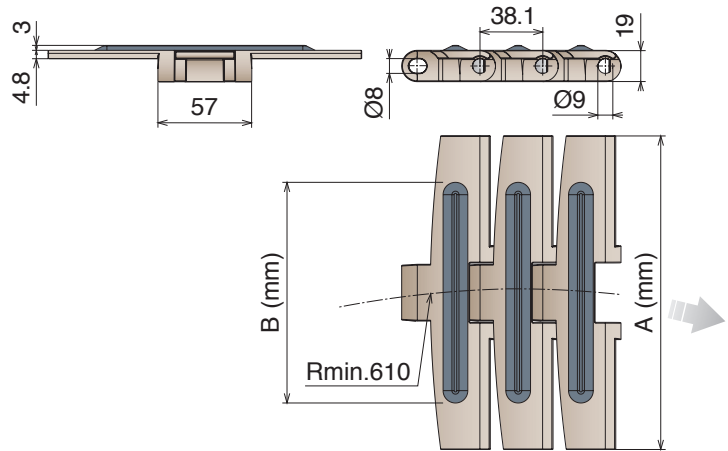
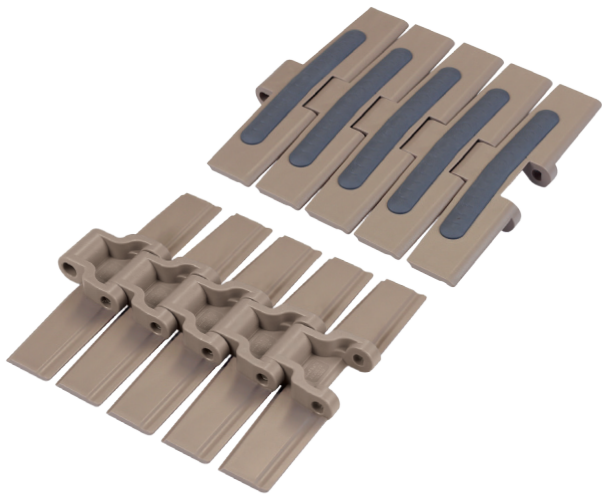

Magnetic System

10 feet
3.048 m
80 links

pg. 92-93/106

pg. 126->131

pg. 464->471

Article-Nr.	Ref.	A (Plate Width) mm	B (Rubber Width) mm	Weight kg/ m	Max working load (N)	Material
11150107	LF 882 M GT K750	190,5	134,0	2,10	3830	LF
11150108	LF 882 M GT K1000	254,0	197,0	2,45		
11150109	LF 882 M GT K1200	304,8	249,0	2,74		
11150307	MX 882 M GT K750	190,5	134,0	2,10	3050	MX
11150308	MX 882 M GT K1000	254,0	197,0	2,45		
11150309	MX 882 M GT K1200	304,8	249,0	2,74		

882 M LBP

Catene in plastica / Plastic chains / Scharnierbandketten aus Kunststoff

882 M LBP

Catena curvilinea
Sideflexing chain / Kurvengängige Scharnierbandkette

Pins: Ferritic Stainless Steel | Backflex radius min.: 150 mm

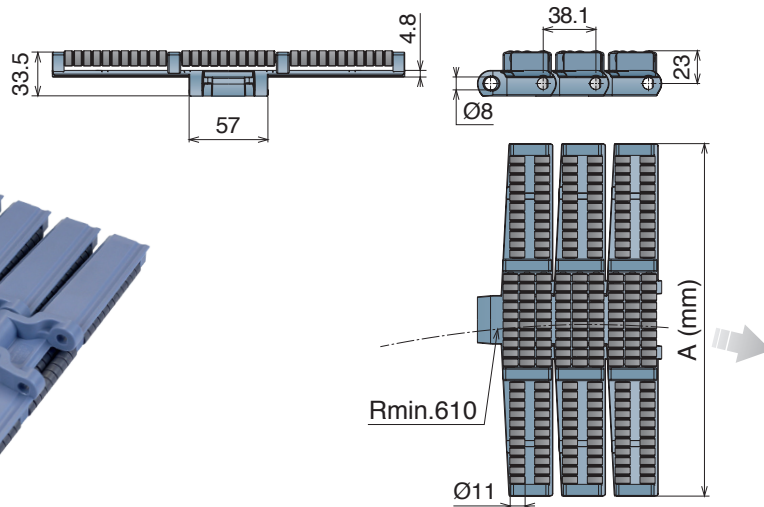
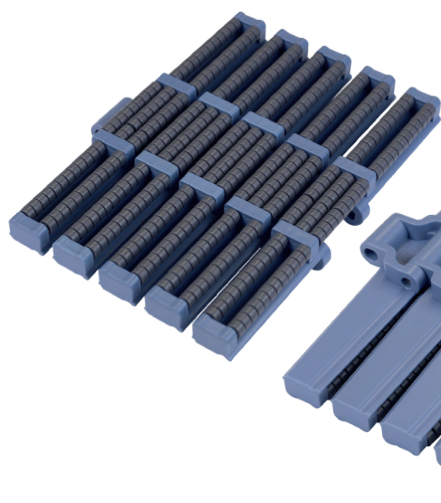

Magnetic System

5 feet 1.524 m			
40 links	pg. 92-93/106	pg. 132->135	pg. 464->471

Article-Nr.	Ref.	A (Plate Width) mm	Weight kg/m	Max working load (N)	Material
11170107	LFA 882 M LBP K750	190,5	3,92	3830	LFA
11170108	LFA 882 M LBP K1000	254,0	4,94		
11170109	LFA 882 M LBP K1200	304,8	5,82		

882 TAB

Catena curvilinea
Sideflexing chain / Kurvengängige Scharnierbandkette

Pins: Stainless Steel | Backflex radius min.: 40 mm

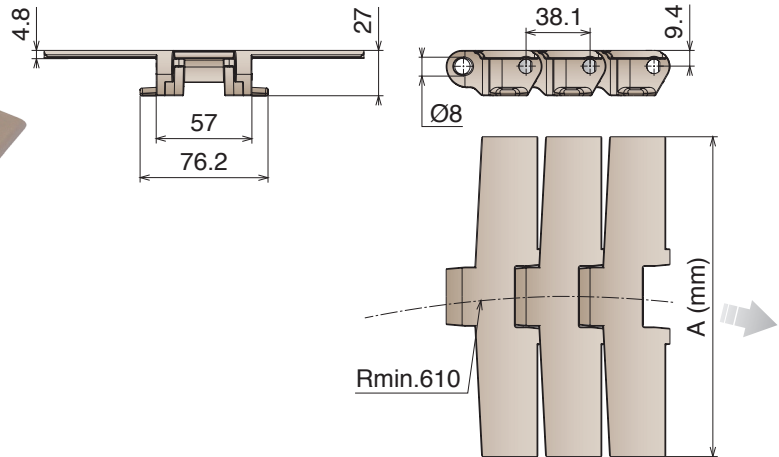

Tab System

10 feet
3.048 m
80 links

pg. 92-93

pg. 158/163

pg. 464->471

Article-Nr.	Ref.	A (Plate Width) mm	Weight kg/m	Max working load (N)	Material
11140105	LF 882 TAB K450	114,3	2,05	3830	LF
11140106	LF 882 TAB K600	152,4	2,20		
11140107	LF 882 TAB K750	190,5	2,45		
11140108	LF 882 TAB K1000	254,0	2,85		
11140109	LF 882 TAB K1200	304,8	3,40		
11140305	MX 882 TAB K450	114,3	2,05	3050	MX
11140306	MX 882 TAB K600	152,4	2,20		
11140307	MX 882 TAB K750	190,5	2,45		
11140308	MX 882 TAB K1000	254,0	2,85		
11140309	MX 882 TAB K1200	304,8	3,40		
11142505	MPX 882 TAB K450	114,3	2,05	3830	MPX
11142506	MPX 882 TAB K600	152,4	2,20		
11142507	MPX 882 TAB K750	190,5	2,45		
11142508	MPX 882 TAB K1000	254,0	2,85		
11142509	MPX 882 TAB K1200	304,8	3,40		
11141605	DKM 882 TAB K450	114,3	2,05	3830	DKM
11141606	DKM 882 TAB K600	152,4	2,20		
11141607	DKM 882 TAB K750	190,5	2,45		
11141608	DKM 882 TAB K1000	254,0	2,85		
11141609	DKM 882 TAB K1200	304,8	3,40		
11141705	MWX 882 TAB K450	114,3	2,05	3830	MWX
11141706	MWX 882 TAB K600	152,4	2,20		
11141707	MWX 882 TAB K750	190,5	2,45		
11141708	MWX 882 TAB K1000	254,0	2,85		
11141709	MWX 882 TAB K1200	304,8	3,40		

882 TAB GT

Catene in plastica / Plastic chains / Scharnierbandketten aus Kunststoff

882 TAB GT

Catena curvilinea
Sideflexing chain / Kurvengängige Scharnierbandkette

Pins: Stainless Steel | Backflex radius min.: 40 mm | TPE Rubber: 75 ShA

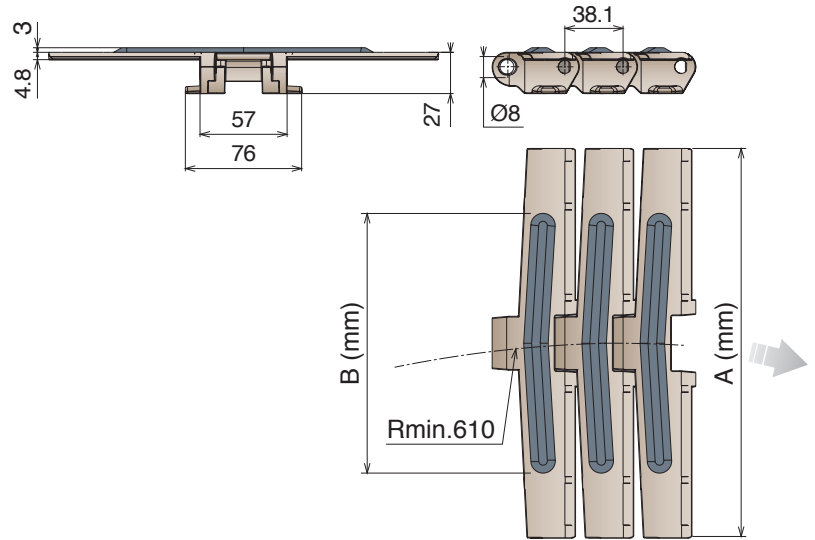

Tab System

10 feet
3.048 m
80 links

pg. 92-93

pg. 158/163

pg. 464->471

Article-Nr.	Ref.	A (Plate Width) mm	B (Rubber Width) mm	Weight kg/ m	Max working load (N)	Material
11160107	LF 882 TAB GT K750	190,5	134,0	2,37	3830	LF
11160108	LF 882 TAB GT K1000	254,0	197,0	2,67		
11160109	LF 882 TAB GT K1200	304,8	249,0	2,92		
11160307	MX 882 TAB GT K750	190,5	134,0	2,37	3050	MX
11160308	MX 882 TAB GT K1000	254,0	197,0	2,67		
11160309	MX 882 TAB GT K1200	304,8	249,0	2,92		

882 TAB LBP

Catena curvilinea
Sideflexing chain / Kurvengängige Scharnierbandkette

Pins: Stainless Steel | Backflex radius min.: 150 mm

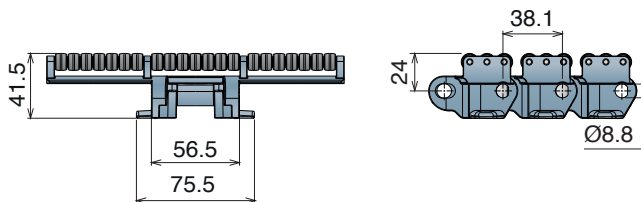

K450

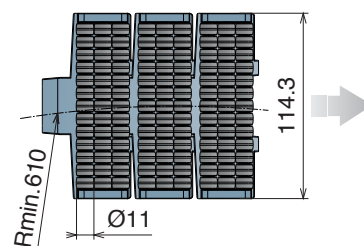

K750

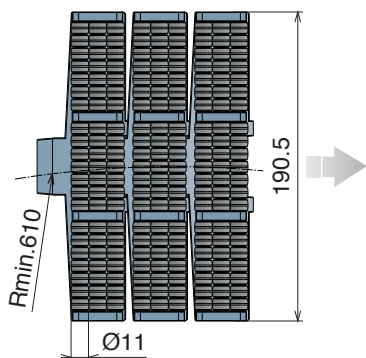

K1000

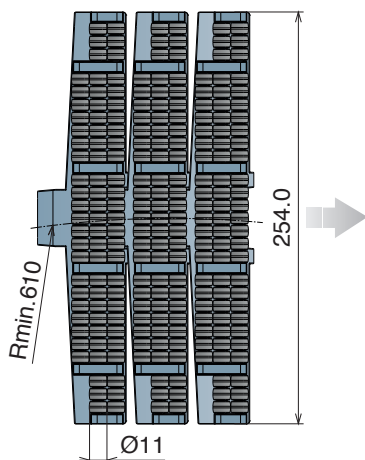

K1200

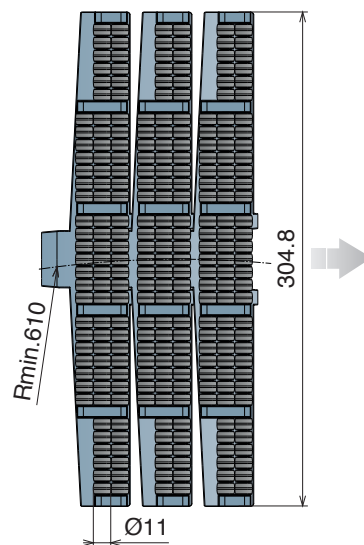

Tab System

5 feet
1.524 m
40 links

pg. 92-93

pg. 158/163

pg. 464->471

Article-Nr.	Ref.	A (Plate Width) mm	Weight kg/m	Max working load (N)	Material
11180105	LFA 882 TAB LBP K450	114,3	4,00	3830	LFA
11180107	LFA 882 TAB LBP K750	190,5	4,70		
11180108	LFA 882 TAB LBP K1000	254,0	5,95		
11180109	LFA 882 TAB LBP K1200	304,8	6,55		

1873 Catena curvilinea Sideflexing chain / Kurvengängige Scharnierbandkette

The stainless steel version is supplied with LONG-LIFE SS roller chain.

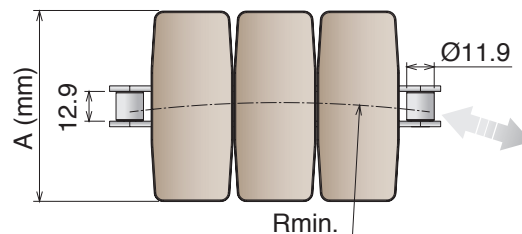
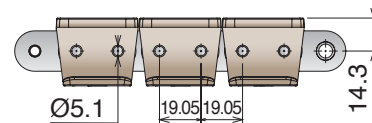
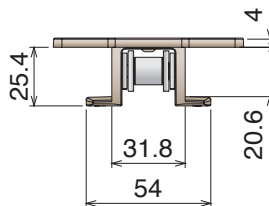
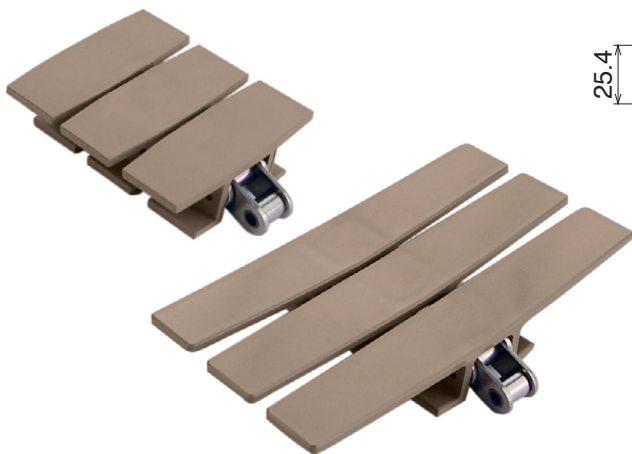

80 flights

SPROCKET

ASA 60
Standard on market



pg. 159/164



pg. 464->471

Tab System

Standard length roller chain: 160 Pitches

Article-Nr.	Chain	Ref.	A (Plate Width) mm	R mm	Weight kg/m	Max working load (N)	Backflex radius min. mm	Material
11590102	C45	LF 1873 TAB K325	82,5	355	2,10	4500	180	LF
11600102	Stainless Steel		82,5	355	2,10	3500		
11590105	C45	LF 1873 TAB K450	114,3	355	2,30	4500		
11600105	Stainless Steel		114,3	355	2,30	3500		
11590106	C45	LF 1873 TAB K600	152,4	457	2,40	4500		
11600106	Stainless Steel		152,4	457	2,40	3500		
11590107	C45	LF 1873 TAB K750	190,5	457	2,60	4500		
11600107	Stainless Steel		190,5	457	2,60	3500		
11590108	C45	LF 1873 TAB K1000	254,0	457	2,80	4500		
11600108	Stainless Steel		254,0	457	2,80	3500		
11590109	C45	LF 1873 TAB K1200	304,8	457	3,00	4500		
11600109	Stainless Steel		304,8	457	3,00	3500		
11590302	C45	MX 1873 TAB K325	82,5	355	2,10	4500	180	MX
11600302	Stainless Steel		82,5	355	2,10	3500		
11590305	C45	MX 1873 TAB K450	114,3	355	2,30	4500		
11600305	Stainless Steel		114,3	355	2,30	3500		
11590306	C45	MX 1873 TAB K600	152,4	457	2,40	4500		
11600306	Stainless Steel		152,4	457	2,40	3500		
11590307	C45	MX 1873 TAB K750	190,5	457	2,60	4500		
11600307	Stainless Steel		190,5	457	2,60	3500		
11590308	C45	MX 1873 TAB K1000	254,0	457	2,80	4500		
11600308	Stainless Steel		254,0	457	2,80	3500		
11590309	C45	MX 1873 TAB K1200	304,8	457	3,00	4500		
11600309	Stainless Steel		304,8	457	3,00	3500		

1873 GT Catena curvilinea Sideflexing chain / Kurvengängige Scharnierbandkette

The stainless steel version is supplied with LONG-LIFE SS roller chain.

TPE Rubber: 75 ShA

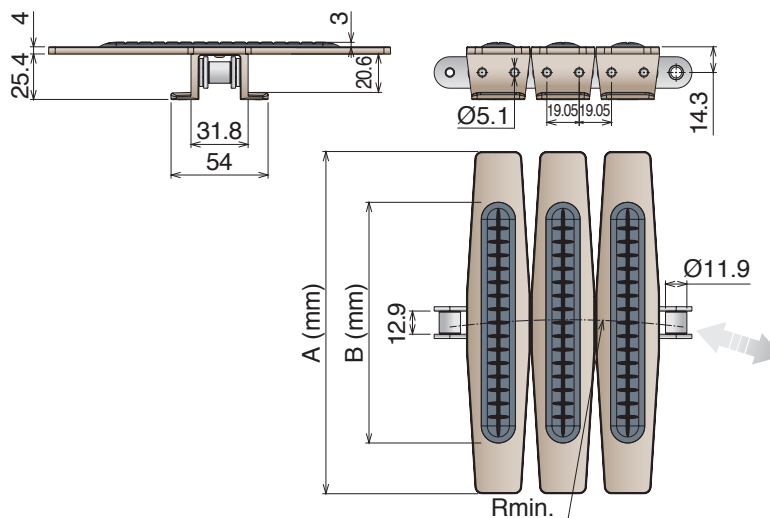

Tab System

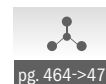
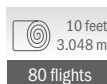

Standard length roller chain: 160 Pitches

Article-Nr.	Chain	Ref.	A (Plate Width) mm	B (Rubber Width) mm	Weight kg/m	Max working load (N)	Sideflex radius min. mm	Material
11610107	C45	LF 1873 GT TAB K750	190,5	134,0	2,60	4500	457	LF
11620107	Stainless Steel		190,5	134,0	2,60	3500		
11610108	C45	LF 1873 GT TAB K1000	254,0	192,0	2,80	4500		
11620108	Stainless Steel		254,0	192,0	2,80	3500		
11610109	C45	LF 1873 GT TAB K1200	304,8	252,0	3,00	4500	457	
11620109	Stainless Steel		304,8	252,0	3,00	3500		
11610307	C45	MX 1873 GT TAB K750	190,5	134,0	2,60	4500	457	MX
11620307	Stainless Steel		190,5	134,0	2,60	3500		
11610308	C45	MX 1873 GT TAB K1000	254,0	192,0	2,80	4500		
11620308	Stainless Steel		254,0	192,0	2,80	3500		
11610309	C45	MX 1873 GT TAB K1200	304,8	252,0	3,00	4500	457	
11620309	Stainless Steel		304,8	252,0	3,00	3500		

1873 MX1

Catene in plastica / Plastic chains / Scharnierbandketten aus Kunststoff

1873 MX1 Catena curvilinea Sideflexing chain / Kurvengängige Scharnierbandkette

New

The stainless steel version is supplied with LONG-LIFE SS roller chain.

TPR Rubber: 75 ShA

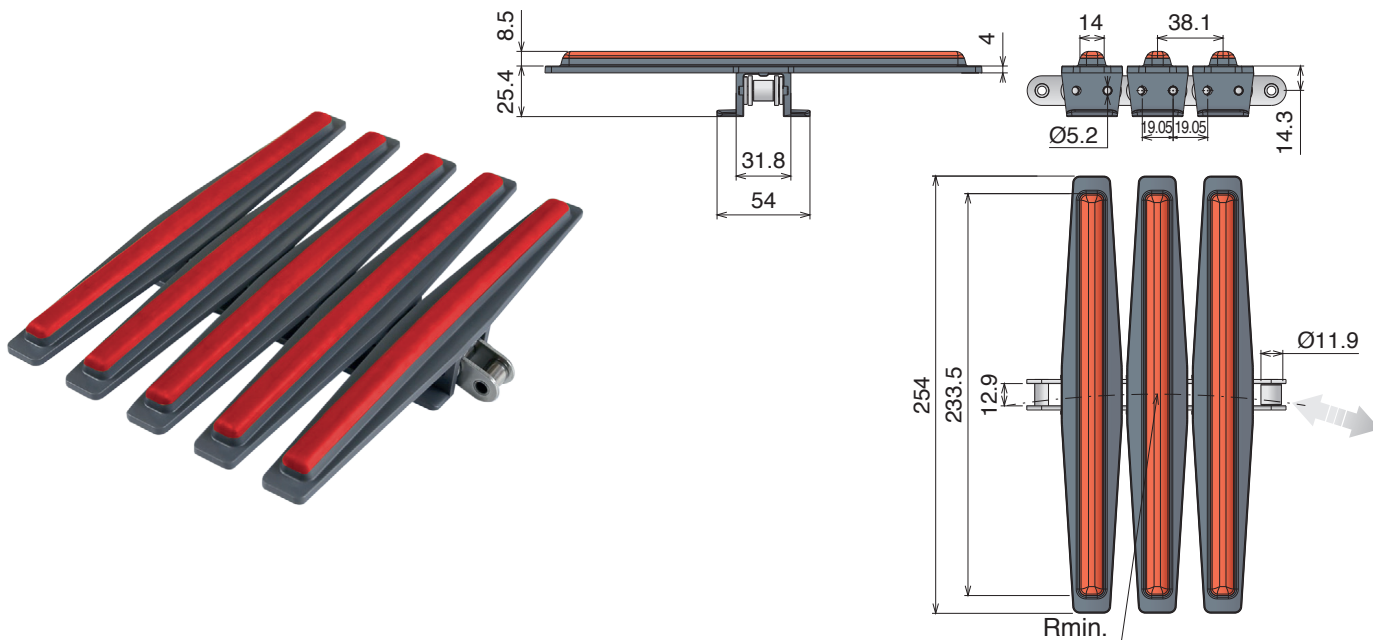

Tab System

10 feet
3.048 m
80 flights

SPROCKET
ASA 60
Standard on market

pg. 159/164

pg. 464->471

Standard length roller chain: 160 Pitches

Article-Nr.	Chain	Ref.	A (Plate Width) in-mm	Weight lbs/ft-kg/m	Max working load (lbs/N)	Sideflex radius min. in-mm	Material
11790108	C45				4500		
11780108	Nickel Plated Steel	1873 LFTAB K1000	254,0	2,80	3500	457	LF
11690108	Stainless Steel				3500		
11790308	C45				4500		
11780308	Nickel Plated Steel	1873 MX1 TAB K1000	254,0	2,80	3500	457	MX
11690308	Stainless Steel				3500		

1873 MX1

Chain for hot-fill applications, neck & cap sterilizing.

+ **ExtraInfo**

+ Care

Designed to keep the products in the correct position during the twist movement.

+ Temperature resistance

The rubber is developed for and perfectly resistant against the higher temperatures of the hot-filled products.

+ Long life roller chain

Special hardened pins and bushing guarantee a longer lifetime. Chain can twist 90° in 1500 mm.

+ Product stability

The new developed design guarantees a perfect connection between rubber and plate.

1873 MX2 Catena curvilinea Sideflexing chain / Kurvengängige Scharnierbandkette

New

The stainless steel version is supplied with LONG-LIFE SS roller chain.

TPR Rubber: 75 ShA

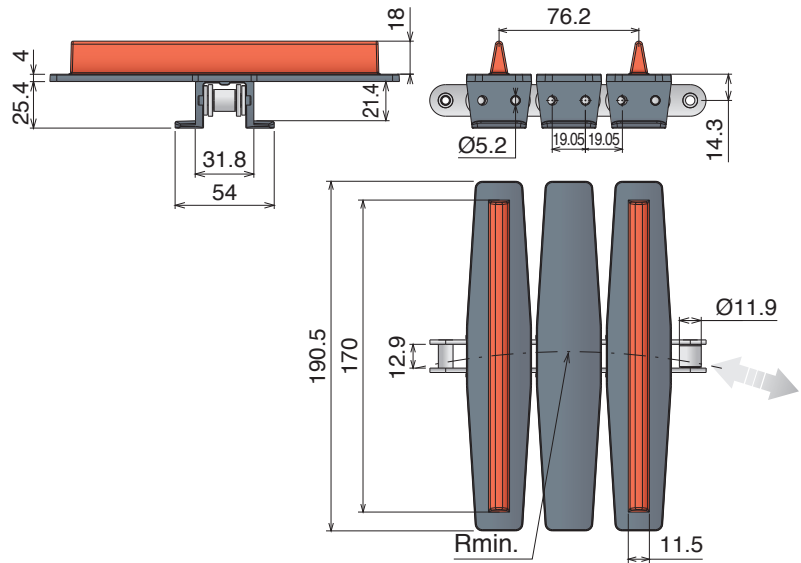

Standard length roller chain: 160 Pitches

Tab System

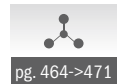
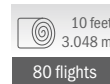

Article-Nr.	Chain	Ref.	A (Plate Width) in-mm	Weight lbs/ft-kg/m	Max working load (lbs/N)	Sideflex radius min. in-mm	Material
11770107	C45	1873 LF TAB K750	190,5	2,60	4500	457	LF
11760107	Nickel Plated Steel				3500		
11670107	Stainless Steel				3500		
11770307	C45	1873 MX2 TAB K750	190,5	2,60	4500	457	MX
11760307	Nickel Plated Steel				3500		
11670307	Stainless Steel				3500		

1873 MX2

Chain for twisting cans.

+ Care

Designed to twist cans without pressure.

+ Temperature resistance

Materials are suitable for use at high temperatures.

+ Long life roller chain

Special hardened pins and bushing guarantee a longer lifetime. Chain can twist 90° in 1500 mm.

+ ExtraInfo

+ Product stability

The flights assure the position of the cans also at higher speed.



1843 Catena curvilinea Sideflexing chain / Kurvengängige Scharnierbandkette

New

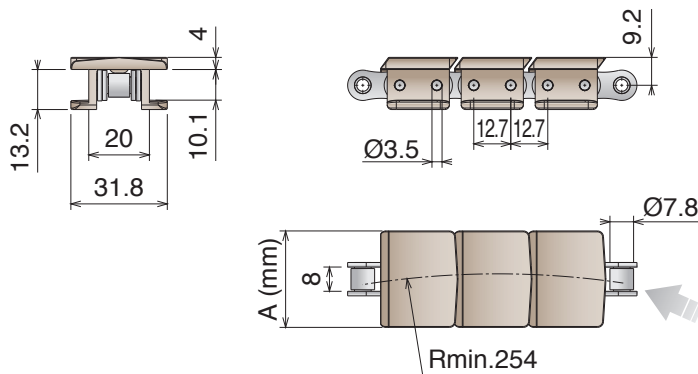

Standard length roller chain: 240 Pitches

Tab System

10 feet
3.048 m
120 links

SPROCKET
ASA 60
Standard on market

pg. 160/165

pg. 464->471

Article-Nr.	Chain	Ref.	A (Plate Width) mm	R mm	Weight kg/m	Max working load (N)	Backflex radius min. mm	Material
11400117	C45	LF 1843 TAB K125	31,8	254	0,74	2700	50	LF
11410117	Stainless Steel		31,8	254	0,74	1900		
11400119	C45	LF 1843 TAB K200	50,8	254	0,89	2700		
11410119	Stainless Steel		50,8	254	0,89	1900		
11400317	C45	MX 1843 TAB K125	31,8	254	0,74	2700	50	MX
11410317	Stainless Steel		31,8	254	0,74	1900		
11400319	C45	MX 1843 TAB K200	50,8	254	0,89	2700		
11410319	Stainless Steel		50,8	254	0,89	1900		

SP 1883

Catene in plastica / Plastic chains / Scharnierbandketten aus Kunststoff

SP 1883

Catena curvilinea
Sideflexing chain / Kurvengängige Scharnierbandkette

New

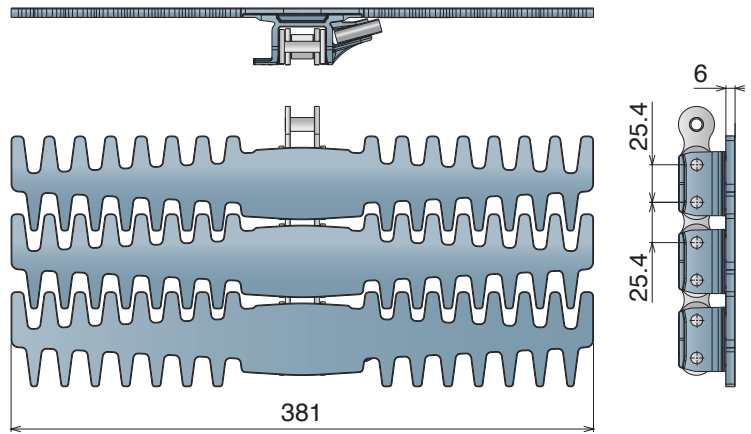
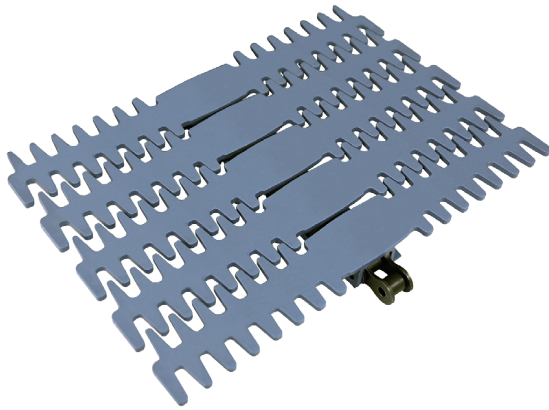

Standard length roller chain: 120 Pitches



SPROCKET
ASA 80
Standard on
market

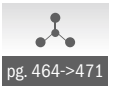

Article-Nr.	Chain	Ref.	A (Plate Width) mm	Weight kg/m	Max working load (N)	Sideflex radius min. mm	Material
11640110	C45	LFA SP 1883 TAB K1500	381,0	12,5	6500	711	LFA
11640310	Stainless Steel		381,0	12,5	5500		

Spiral Conveyor Technology

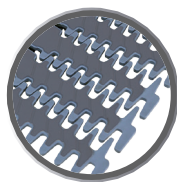

Grip Top

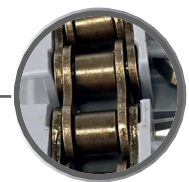

Reinforced Chain C45 or SS Pitch 25.4 mm

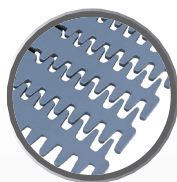

Flat Top

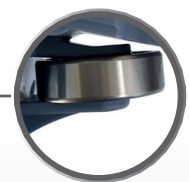

SS Ball Bearing

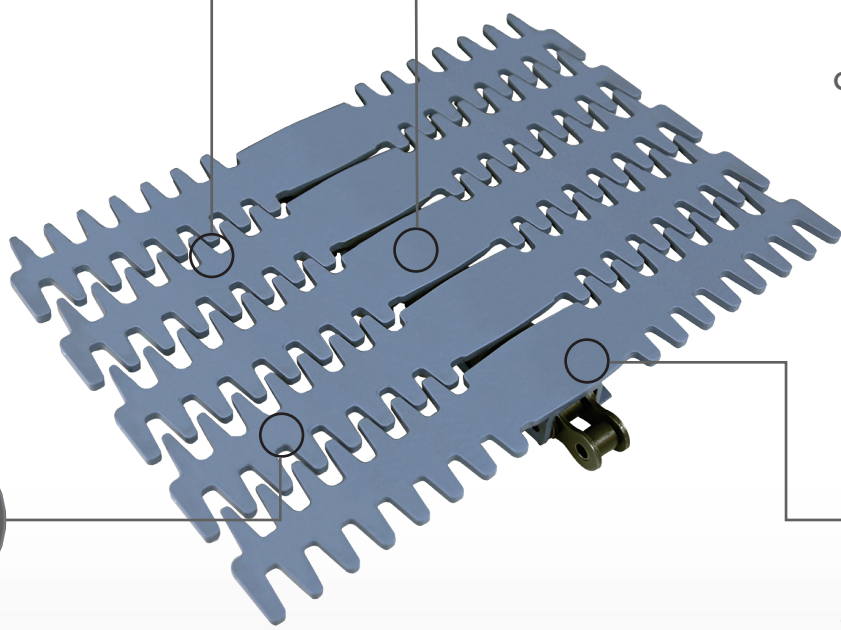

SP 1883 GT

Catena curvilinea
Sideflexing chain / Kurvengängige Scharnierbandkette

New

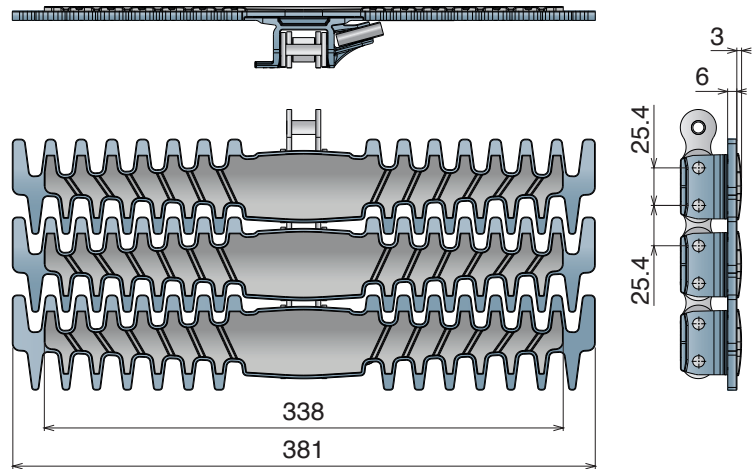
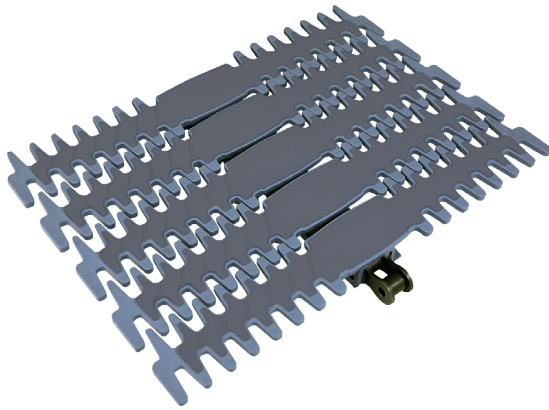

Standard length roller chain: 120 Pitches



SPROCKET
ASA 80
Standard on
market

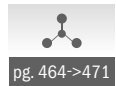

Article-Nr.	Chain	Ref.	A (Plate Width) mm	Weight kg/m	Max working load (N)	Sideflex radius min. mm	Material
11650110	C45	LFA SP 1883 GT TAB K1500	381,0	13,0	6500	711	LFA
11650310	Stainless Steel		381,0	13,0	5500		

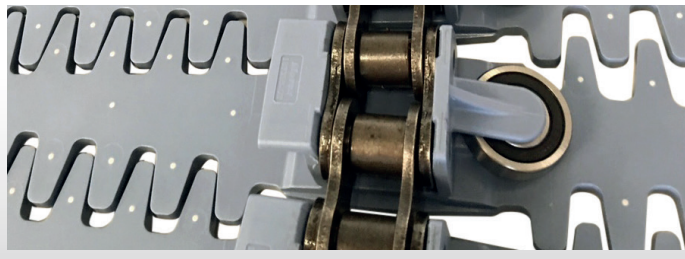

1701 TAB OP

Catena curvilinea
Sideflexing chain / Kurvengängige Scharnierbandkette

New

Pins: Stainless Steel | Backflex radius min.: 50 mm

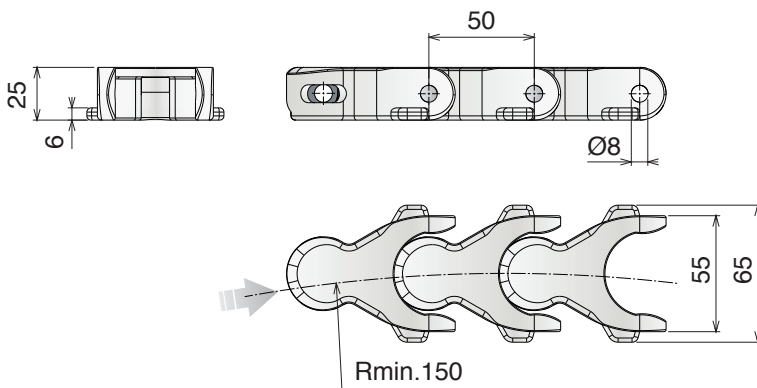

Tab System

10 feet
3.050 m

61 links

pg. 100

pg. 160/166

pg. 464->471

Article-Nr.	Ref.	A (Plate Width) mm	Weight kg/m	Max working load (N)	Material
11360400	LF 1701 TAB OP	55	1,40	2700	LFN
11360300	MX 1701 TAB OP	55	1,40	2160	MX

1701 TAB OPF

Catene in plastica / Plastic chains / Scharnierbandketten aus Kunststoff

1701 TAB OPF

Catena curvilinea
Sideflexing chain / Kurvengängige Scharnierbandkette

New

Pins: Stainless Steel

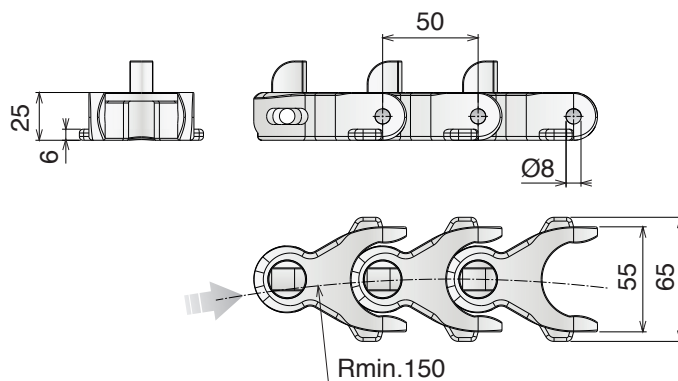

Type A

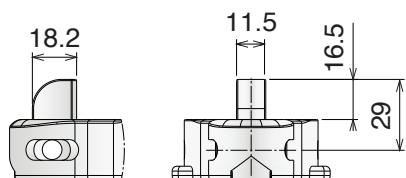

Type B

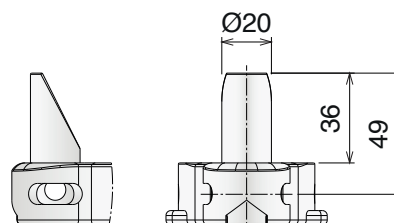

Type C

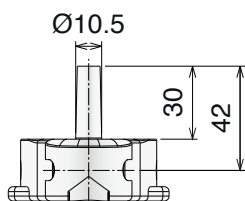

Type D

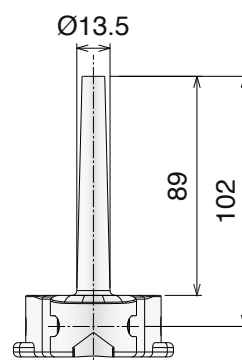

Tab System

10 feet
3.050 m
61 links

pg. 100

pg. 160/166

pg. 464->471

Article-Nr.	Ref.	A (Plate Width) mm	Weight kg/m	Max working load (N)	Material
11360400-FA	1701 TAB Type A	55	1,60	2700	LFN
11360400-FB	1701 TAB Type B	55	1,60		
11360400-FC	1701 TAB Type C	55	2,00		
11360400-FD	1701 TAB Type D	55	2,30		

1706

Catena curvilinea
Sideflexing chain / Kurvengängige Scharnierbandkette

New

Pins: Stainless Steel | Backflex radius min.: 50 mm

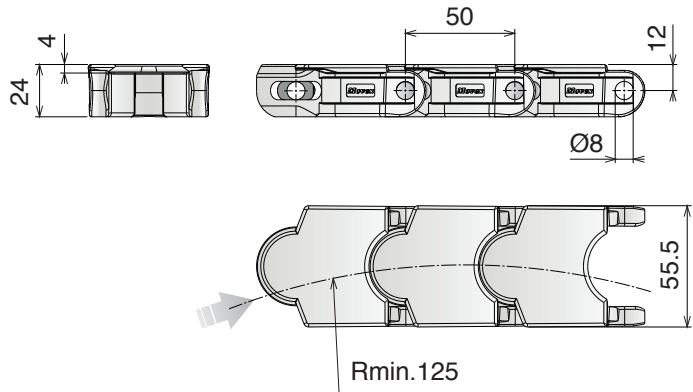

Article-Nr.	Ref.	A (Plate Width) mm	Weight kg/m	Max working load (N)	Material
11720400	LF 1706	55,5	1,35	2300	LFN
11720300	MX 1706	55,5	1,35	1900	MX

1706 TAB

Catena curvilinea
Sideflexing chain / Kurvengängige Scharnierbandkette

New

Pins: Stainless Steel | Backflex radius min.: 50 mm

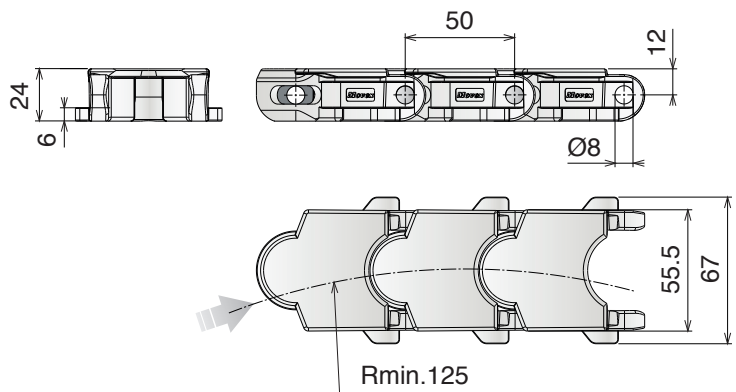

Tab System

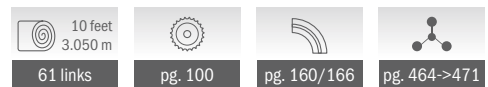

Article-Nr.	Ref.	A (Plate Width) mm	Weight kg/m	Max working load (N)	Material
11730400	LF 1706 TAB	55,5	1,38	2300	LFN
11730300	MX 1706 TAB	55,5	1,38	1900	MX

765 NO GAP

Catene in plastica / Plastic chains / Scharnierbandketten aus Kunststoff

765 NO GAP

Catena curvilinea
Sideflexing chain / Kurvengängige Scharnierbandkette

New

Pins: Stainless Steel | Backflex radius min.: 50 mm

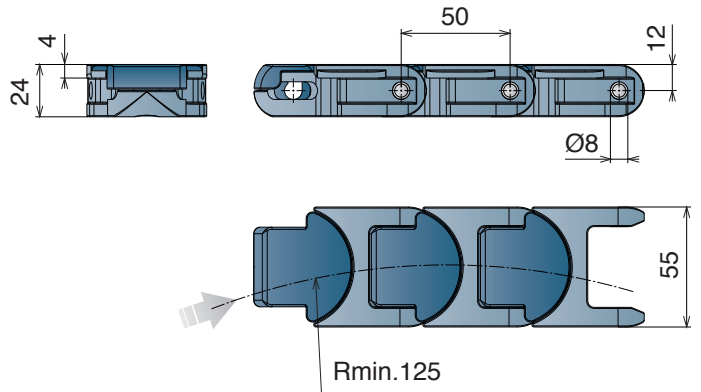

10 feet 3.050 m	pg. 100	pg. 160/166	pg. 464->471
61 links			

Article-Nr.	Ref.	A (Plate Width) mm	Weight kg/m	Max working load (N)	Material
11940100	765 LFA NO GAP	55	1,46	2670	LFA

43 MF-63 MF-83 MF-103 MF

Catena curvilinea
Sideflexing chain
Kurvengängige Scharnierbandkette

Pins: Stainless Steel | Backflex radius min.: 50 mm



43 MF

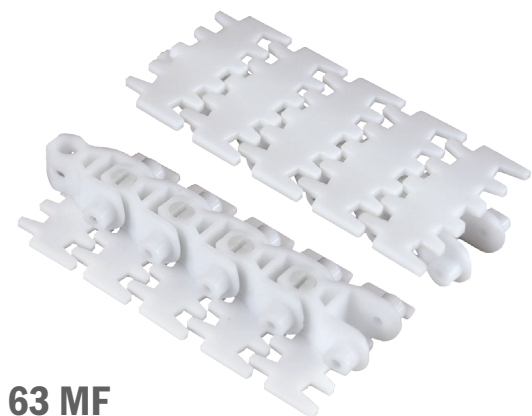
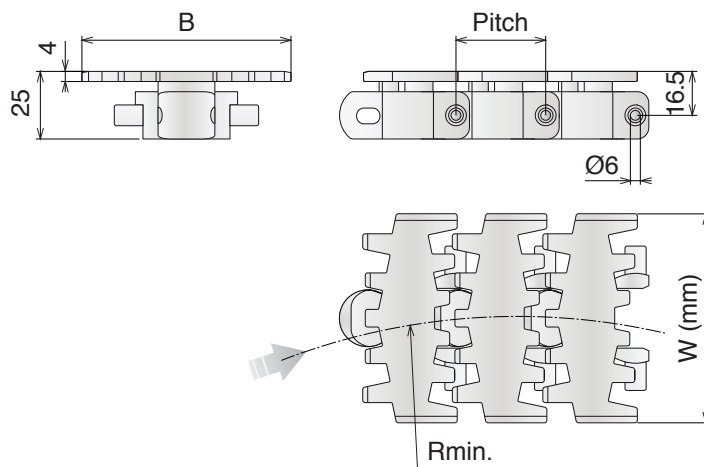

63 MF

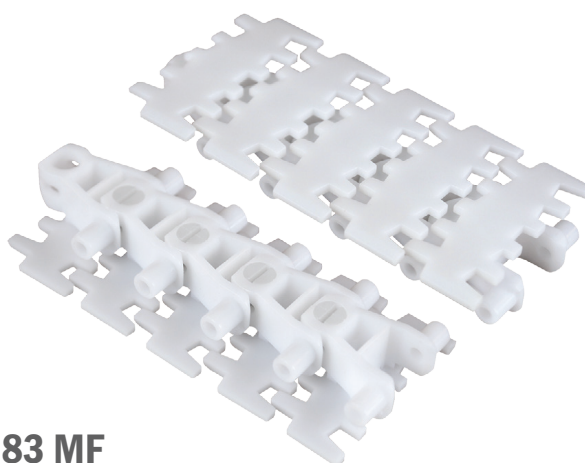

83 MF

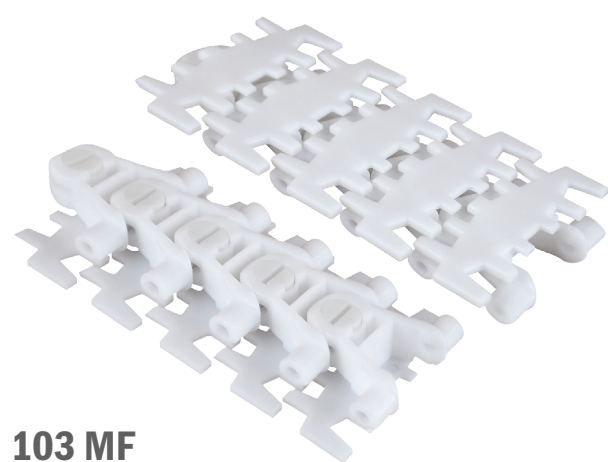

103 MF

New

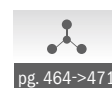

Article-Nr.	Ref.	A (Plate Width) mm	B mm	Weight kg/m	Pitch	Radius min.	Links	Max working load (N)	Material
12010400	43 MF	43	37	0,60	25,4	140	3.048 (120 links)	2100	LFN
12010401	63 MF	63	-	0,80	25,4	150	3.048 (120 links)		
12010402	83 MF	83	58	1,70	33,5	160	3.015 (90 links)		
12010403	103 MF	103	75	2,00	33,5	170	3.015 (90 links)		

83 M-140 M

Catene in plastica / Plastic chains / Scharnierbandketten aus Kunststoff

83 M-140 M

Catena curvilinea
Sideflexing chain / Kurvengängige Scharnierbandkette

New

Pins: Stainless Steel



83 M

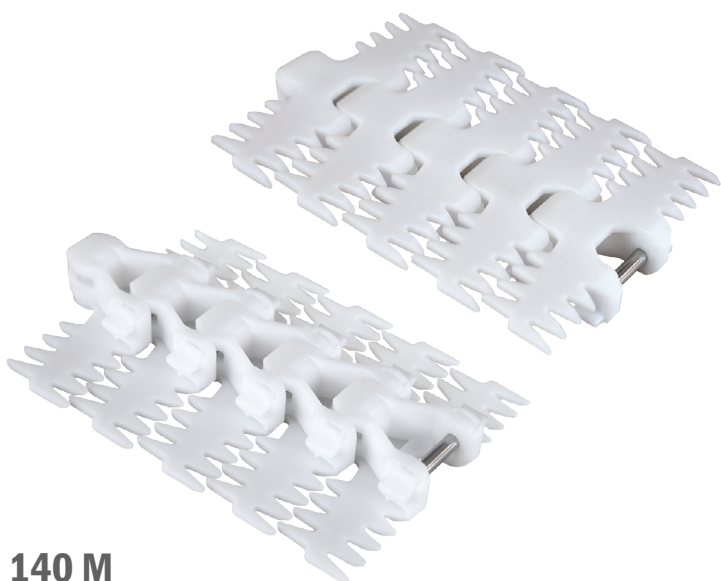
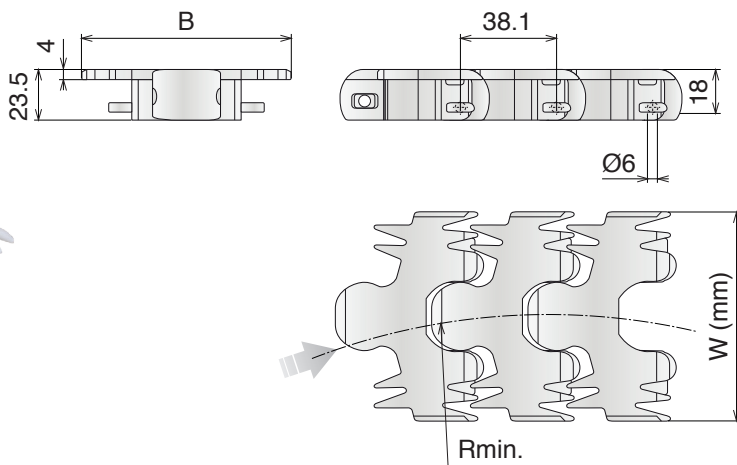

140 M



Article-Nr.	Ref.	A (Plate Width) mm	B mm	Weight kg/m	Pitch	Radius min.	Max working load (N)	Material
12020402	83 M	83	63	1,35	38,1	150	2100	LFN
12020404	140 M	140	63	2,10	38,1	250		

83 M/PU

Catena curvilinea
Sideflexing chain / Kurvengängige Scharnierbandkette

New

Pins: Stainless Steel

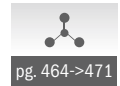
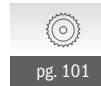
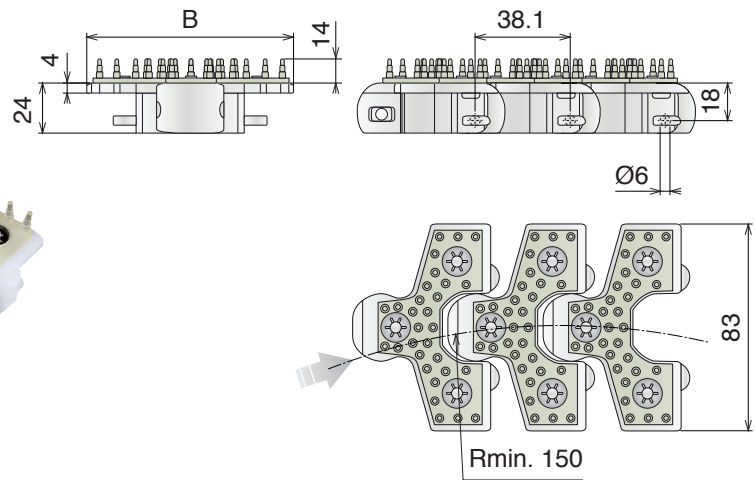
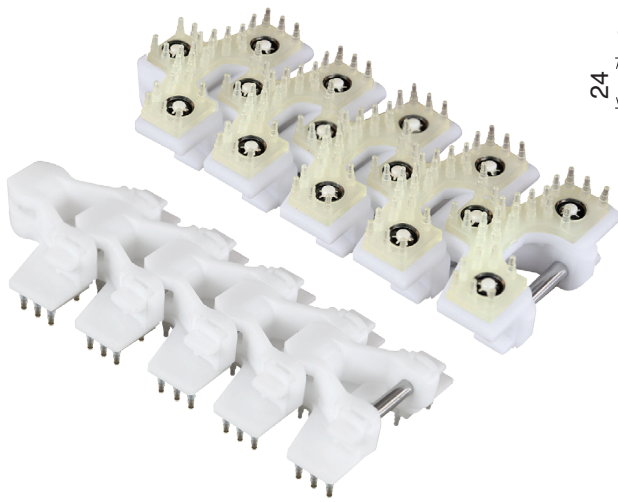

Article-Nr.	Ref.	A (Plate Width) mm	B mm	Weight kg/m	Pitch	Radius min.	Max working load (N)	Material
12030402	83 M/PU	83	63	0,80	38,1	150	2100	LFN